

**SINGER**  
**591D200A,D300A**

# **MACHINE PARTS CHART**

## **for**

# **SINGER\***

**591** D200A

**591** D300A

# SINGER\*

## 591 D200A / 300A

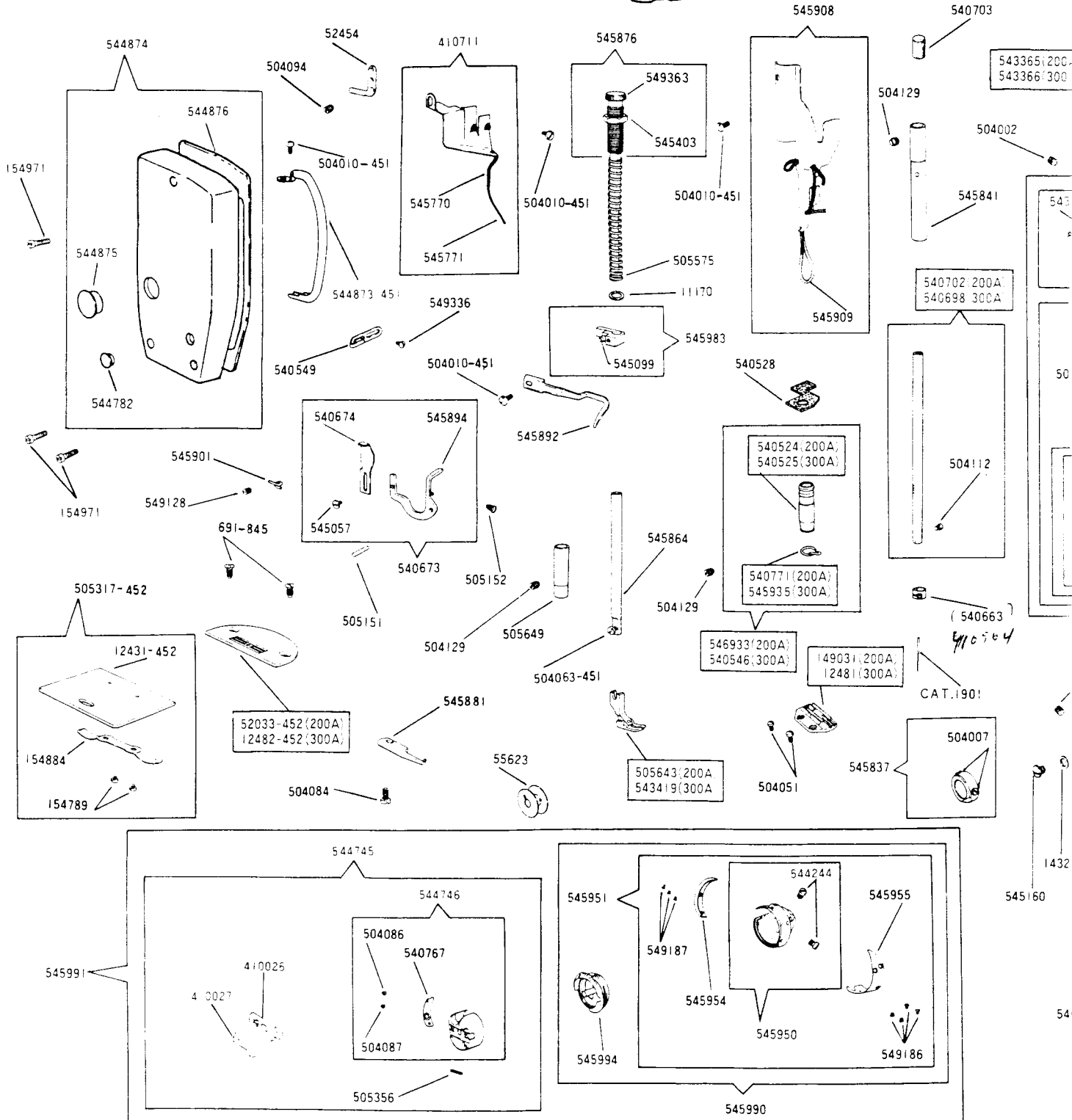
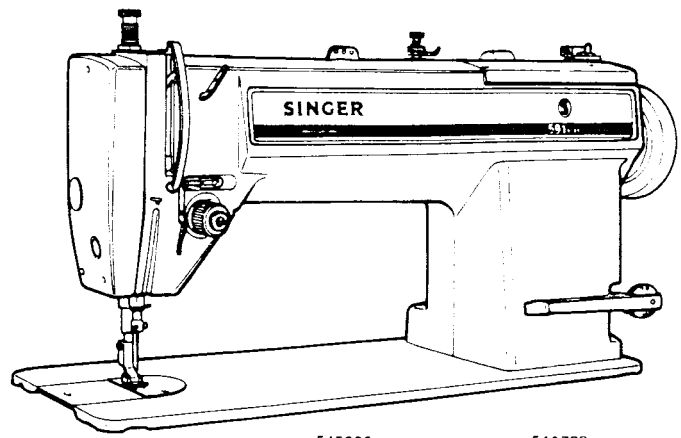

545940 NEEDLES FOR TO USE 80/11 NEEDLES

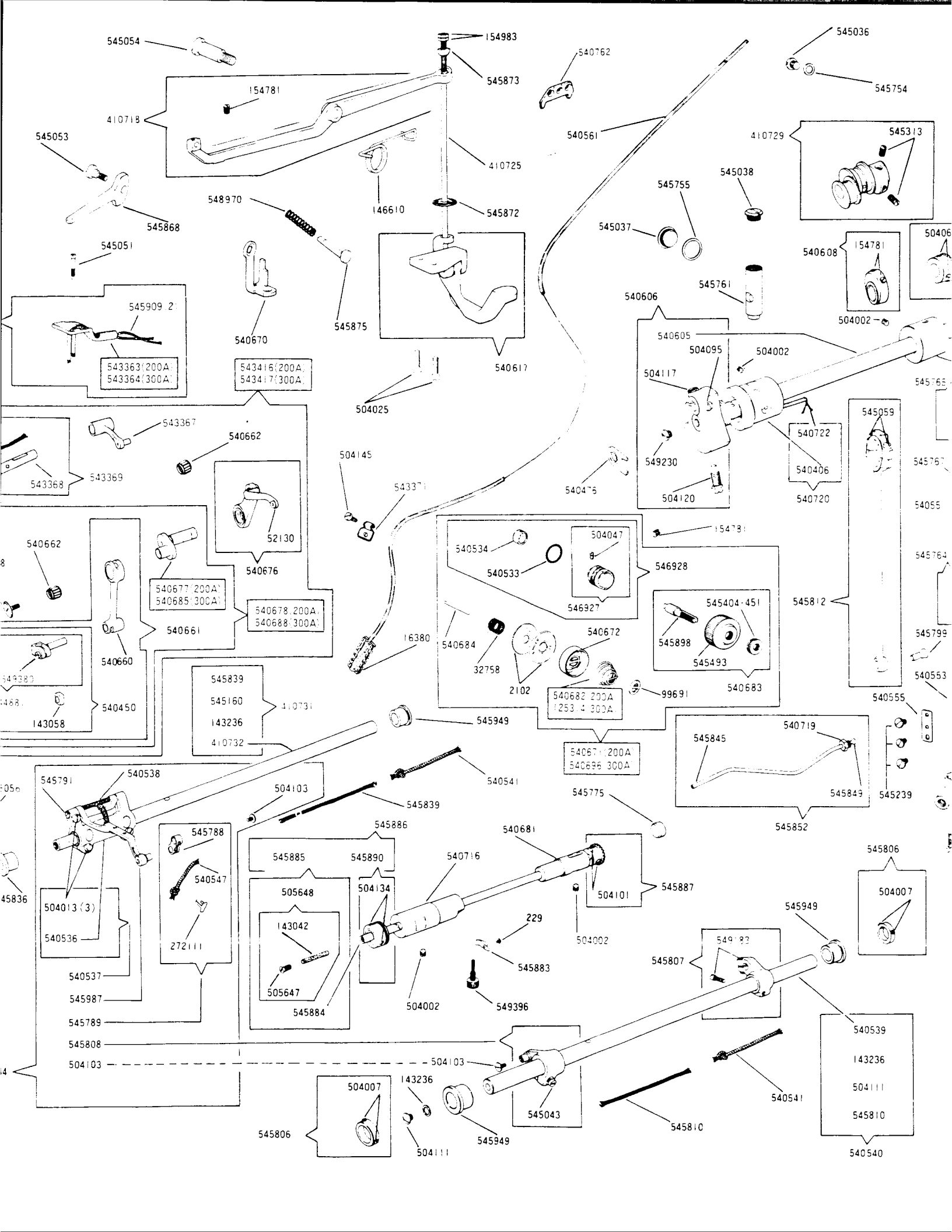

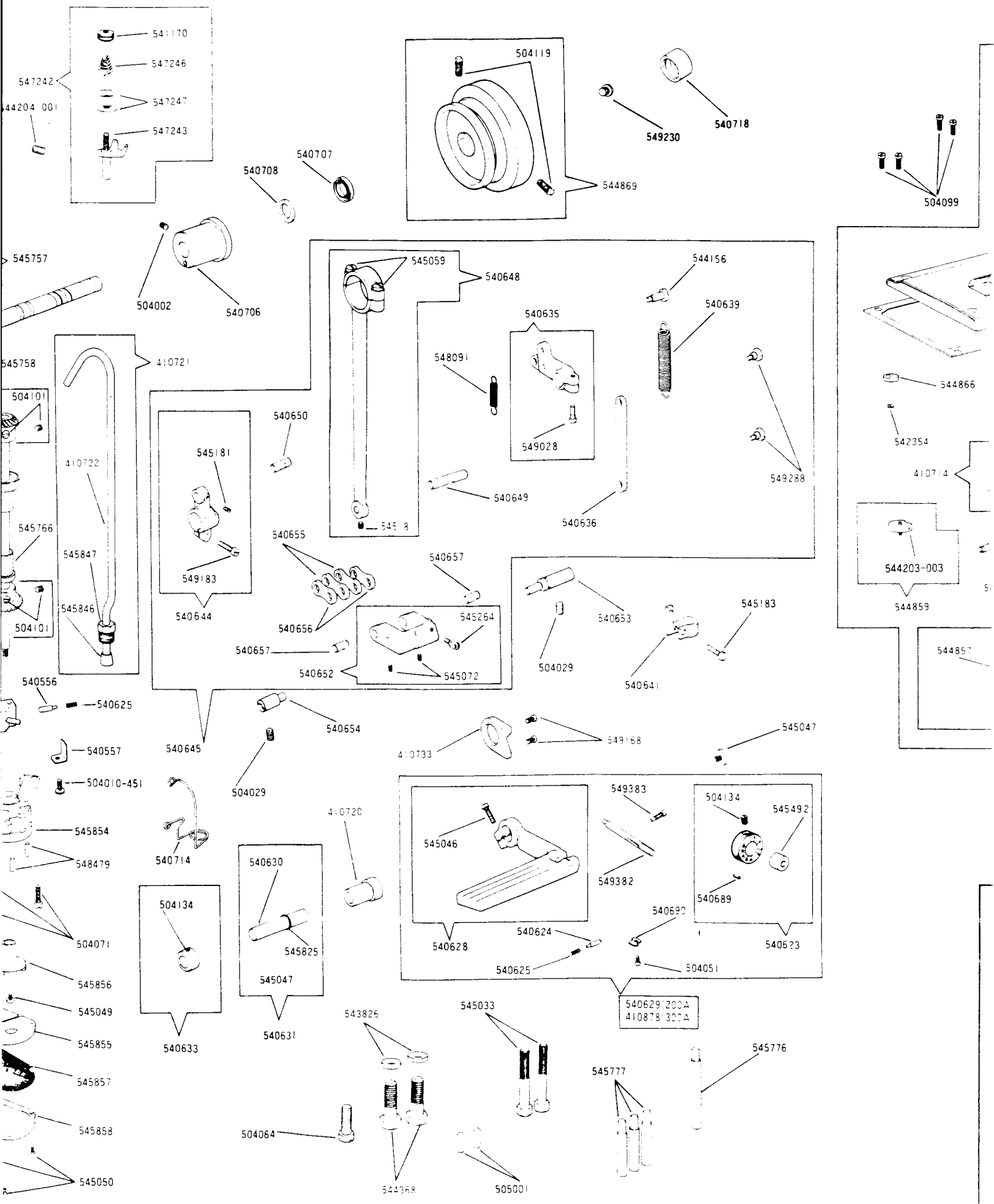

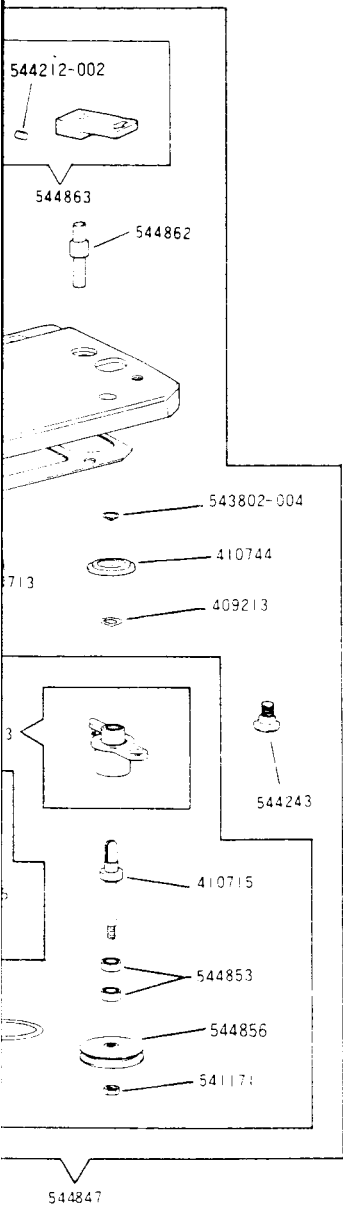

**ACCESSORIES AND ATTACHMENTS**

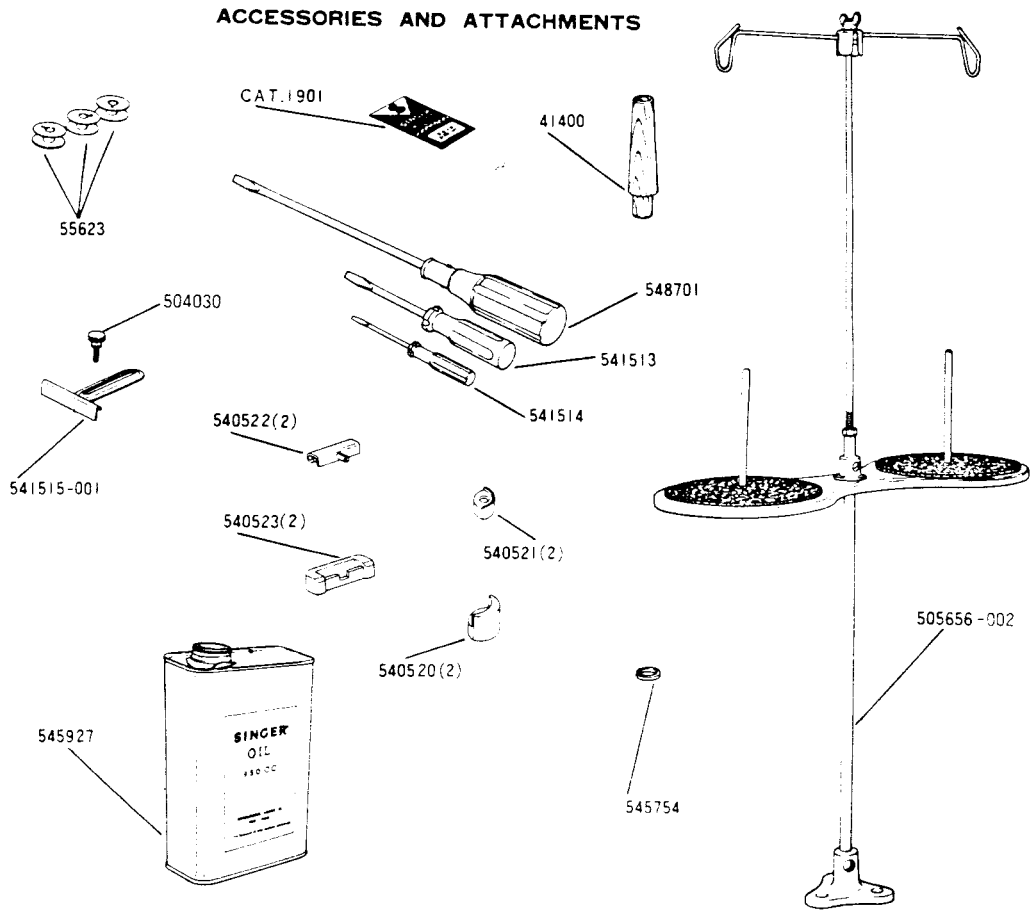

**MACHINE BASE AND OIL RESERVOIR**

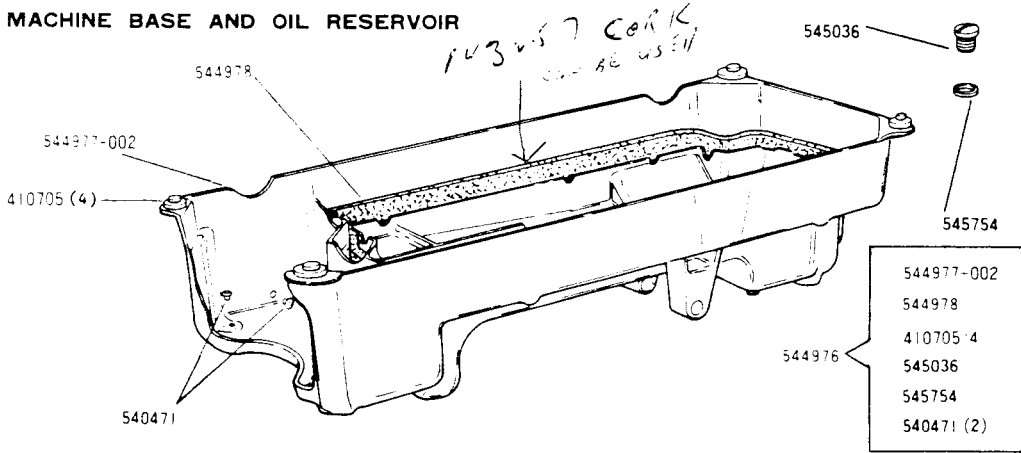

**AVAILABLE AT EXTRA CHARGE**

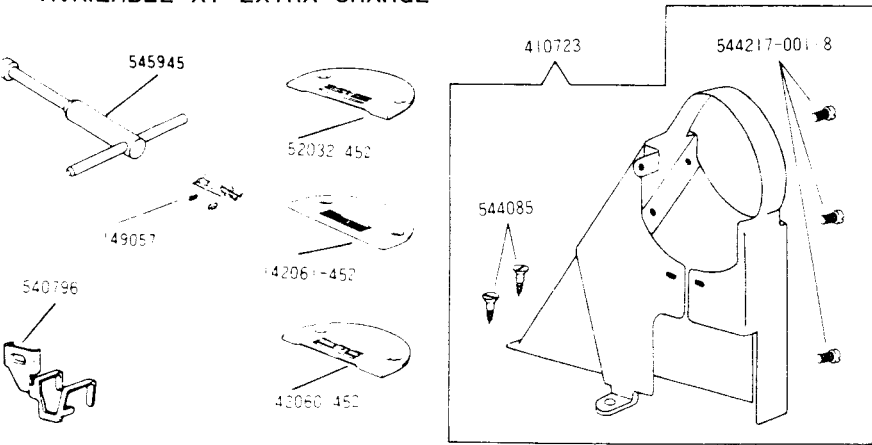

**KNEE LIFTER PARTS**

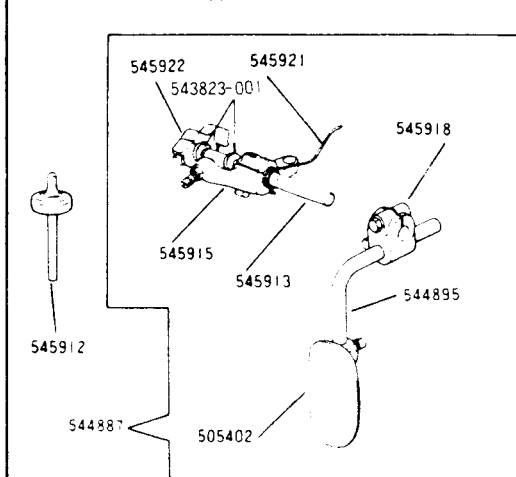

**NUMERICAL LIST OF PARTS FOR MACHINE 591D200A/D300A**

<b>PART NO.</b>	<b>DESCRIPTION</b>	<b>PART NO.</b>	<b>DESCRIPTION</b>
545765	Arm Shaft (upright) Bevel Gear (upper) Left Hand Spiral with two 504101	547243	Bobbin Winder Tension Stud
545766	Arm Shaft (upright) Bushing (lower)	547246	Bobbin Winder Tension Spring
545767	Arm Shaft (upright) Bushing (upper)	547247	Bobbin Winder Tension Disc (2)
545770	Arm Side Shield Wick Spring Holder	548091	Feed Rock Shaft Driving Frame Spring
545771	Arm Side Shield Wick	548479	Oil Pump (centrifugal) (body) Position Pin (2)
545775	Bed Hole Plug	548970	Presser Bar Lifting Lever Pin Spring
545776	Bed Leg (long)	549028	Feed Reverse Lever Hinge Stud Crank Clamping Screw
545777	Bed Leg (short) (3)	549128	Thread Eyelet (side of arm) Screw
545788	Feed Bar Connecting Link	549168	Feed Regulating Plate Screw (2)
545789	Feed Bar Connecting Link 545788 with 272111 and 540547	549183	Feed Lifting Rock Shaft Crank (back) Clamping Screw (2)
545791	Feed Bar Hinge Pin	549183	Feed Rock Shaft Crank Clamping Screw
545799	Feed Lifting Rock Shaft Crank (back) Connecting Rod Hinge Stud	549186	Rotating Hook Thread Guard Screw (4)
545806	Feed Lifting Rock Shaft Collar with two 504007 (2)	549187	Rotating Hook Section Screw (3)
545807	Feed Lifting Rock Shaft Crank (back) with two 549183	549230	Arm Shaft (horizontal) Screw Plug (2)
545808	Feed Lifting Rock Shaft Crank (front) with 545043	549288	Feed Reverse Lever Hinge Stud Crank Connecting Link Screw (2)
545810	Feed Lifting Rock Shaft Oil Wick (cotton)	549336	Thread Guard (side of arm) Screw
545812	Feed Lifting Rock Shaft Crank (back) Connecting Rod with two 545059	549363	Presser Bar Guide and Pressure Regulating Thumb Screw
545825	Feed Reverse Lever Hinge Stud O-ring	549380	Needle Bar Connecting Stud Clamping Screw
545836	Feed Rock Shaft Flanged Bushing (front)	549382	Feed Regulating Screw
545837	Feed Rock Shaft Collar with two 504007	549383	Feed Regulating Screw Guide Screw
545839	Feed Rock Shaft Oil Wick (cotton)	549396	Rotating Hook Oil Flow Regulating Thumb Screw
545841	Needle Bar Bushing (upper)	CAT. 1901	Needle (135 x 7 #14) (for 200A)
545845	Oil Pipe	CAT. 1901	Needle (135 x 7 #16) (for 300A)
545846	Oil Pipe Clamping Sleeve		
545847	Oil Pipe Clamping Sleeve Nut	41400	Machine Rest Pin (wood)
545849	Oil Pipe Clamping Sleeve	55623	Rotating Hook Bobbin (3)
545852	Oil Pipe 545845 with 540719 and 545849	504034	Cloth Guide Screw
545854	Oil Pump (centrifugal)	505656-002	Thread Unwinder (for two spools) Complete, with three Wood Screw
545855	Oil Pump (centrifugal) Cover	540520	Machine Base and Oil Reservoir Cushion (front) with two Wire Nail (2)
545856	Oil Pump (centrifugal) Impeller	540521	Machine Base and Oil Reservoir Cushion (back) with two Wire Nail (2)
545857	Oil Pump (centrifugal) Screen	540522	Machine Hinge Connection (2)
545858	Oil Pump (centrifugal) Screen Frame	540523	Machine Hinge Connection Cushion (2)
545864	Presser Bar (hollow)	541513	Screw Driver (large)
545868	Presser Bar Lifter	541514	Screw Driver (small)
545872	Presser Bar Lifting Lever Connecting Rod Oil Mist Retaining Disc (felt)	541515-001	Cloth Guide
545873	Presser Bar Lifting Lever Connecting Rod Swivel	545754	Machine Base and Oil Reservoir Oil Drain Plug Screw Gasket
545875	Presser Bar Lifting Lever Pin	545927	Oil Can (950cc, filled with Singer Type "C" oil)
545876	Presser Bar Guide and Pressure Regulating Thumb Screw 549363 with 545403	548701	Screw Driver (long)
545881	Rotating Hook Bobbin Case Holder Position Bracket	CAT. 1901	Needle (135 x 7 #14) (for 200A) (3)
545883	Rotating Hook Oil Flow Regulating Thumb Screw Spring	CAT. 1901	Needle (135 x 7 #16) (for 300A) (3)
545884	Rotating Hook Shaft		
545885	Rotating Hook Shaft 545884 with 505648	410705	Machine Rest (rubber) and Felt Complete (4)
545886	Rotating Hook Shaft	540471	Machine Base and Oil Reservoir Plug (2)
545887	Rotating Hook Shaft Bevel Gear (left hand spiral) with two 504101	544976	Machine Base and Oil Reservoir Complete, Nos. 544977-002, 544978, 545036, 545754, two 540471 and four 410705
545890	Rotating Hook Shaft Oil Retaining Collar with two 504134	544977-002	Machine Base and Oil Reservoir
545892	Slack Thread Regulator	544978	Machine Base and Oil Reservoir Gasket
545894	Tension Releasing Lever (body)	545036	Machine Base and Oil Reservoir Oil Drain Plug Screw
545898	Tension Stud	545754	Machine Base and Oil Reservoir Oil Drain Plug Screw Gasket
545901	Thread Eyelet (side of arm)		
545908	Thread Take-up Lever Oil Guard with 545909		
545909	Thread Take-up Lever Oil Guard Wick (cotton)		
545909	Oil Wick (cotton) (2)		
545935	Needle Bar Bushing (lower) Thread Eyelet (for 300A)	505402	Rock Shaft Knee Arm Plate
545949	Feed Lifting Rock Shaft Flanged Bushing (2)	543823-001	Rock Shaft Thrust Washer (2)
545949	Feed Rock Shaft Flanged Bushing (back)	544887	Rock Shaft Complete, Nos. 505402, 543823-001, 545913, 545915, 544895, 545918, 545921 and 545922
545950	Rotating Hook (body) with two 544244	544895	Rock Shaft Knee Arm
545951	Rotating Hook Complete, Nos. 545950, 545954, 545955 three 549187 and four 549186	545912	Bell Crank Plunger
545954	Rotating Hook Section	545913	Rock Shaft
545955	Rotating Hook Thread Guard	545915	Rock Shaft Crank
545983	Presser Bar Guide Bracket with 545099	545918	Rock Shaft Knee Arm Hub
545987	Feed Bar	545921	Rock Shaft Spring
545990	Rotating Hook and Rotating Hook Bobbin Case Holder Complete, Nos. 545951 and 545994	545922	Rock Shaft Stop Dog
545991	Rotating Hook, Rotating Hook Bobbin Case Holder and Rotating Hook Bobbin Case Complete, Nos. 540770 and 545990		
545994	Rotating Hook Bobbin Case Holder	52032-452	Throat Plate (large needle hole) (for D200A)
546927	Thread Take-up Spring Regulator with 504047	142060-452	Throat Plate (small needle hole) (for D300A)
546928	Thread Take-up Spring Regulator 546927 with 540533 and 540534	142061-452	Throat Plate (large needle hole) (for D300A)
546933	Needle Bar Bushing (lower) 540524 with 540771 (for 200A)	149057	Feed Dog, 21 teeth (22 teeth to the inch) (for D300A)
547242	Bobbin Winder Tension Complete, Nos. 547243, 547246, 541170 and two 547247	410723	Belt Guard with two 544085 and eight 544217-001
		540796	Needle Guard (for D200A, D300A)
		544085	Belt Guard (lower) Wood Screw (2)
		544217-001	Belt Guard Screw (4)
		544217-001	Belt Guard Plate Screw (4)
		545945	Box Wrench

**ACCESSORIES AND ATTACHMENTS**

**MACHINE BASE AND OIL RESERVOIR**

**KNEE LIFTER PARTS**

**AVAILABLE AT EXTRA CHARGE**

NUMERICAL LIST OF PARTS FOR MACHINE 591D200A/D300A

PART NO.	DESCRIPTION	PART NO.	DESCRIPTION
229	Rotating Hook Oil Flow Regulating Thumb Screw Spring Screw	504087	Rotating Hook Bobbin Case Tension Spring Screw
691-845	Throat Plate Screw (2)	504094	Thread Retainer Set Screw
2102	Tension Disc (2)	504095	Thread Take-up Crank Set Screw
11170	Presser Bar Spring Washer	504099	Arm Top Cover Screw (4)
12431-452	Bed Slide	504101	Arm Shaft (upright) Bevel Gear (lower) Set Screw (2)
12481	Feed Dog 17 teeth (16 teeth to the inch) (for 300A)	504101	Arm Shaft (upright) Bevel Gear (upper) Set Screw (2)
12482-452	Throat Plate (for heavy material sewing) (for 300A)	504101	Rotating Hook Shaft Bevel Gear Set Screw (2)
16380	Oil Removing Lint Screen	504103	Feed Bar Connecting Link Cup Screw (2)
32758	Thread Take-up Spring	504111	Feed Lifting Rock Shaft Oil Plug Screw
52033-452	Throat Plate (small needle hole) (for 200A)	504112	Needle Set Screw
52130	Thread Take-up Lever Thread Eyelet Bushing	504117	Thread Take-up Crank Clamping Screw
52454	Thread Retainer	504118	Needle Bar Connecting Link Cap Screw
55623	Rotating Hook Bobbin	504119	Machine Pulley Set Screw (2)
99691	Tension Regulating Thumb Nut Washer	504120	Needle Bar Crank Position Screw
125314	Tension Spring (for 300A)	504122	Arm Shaft (horizontal) Oil Plug Screw (2)
143042	Rotating Hook Shaft Oil Filter Wick (felt)	504129	Needle Bar Bushing (lower) Set Screw
143058	Needle Bar Connecting Stud Slide Block	504129	Needle Bar Bushing (upper) Set Screw
143236	Feed Lifting Rock Shaft Oil Plug Screw Washer	504129	Presser Bar Bushing (lower) Set Screw
143236	Feed Rock Shaft Oil Plug Screw Washer	504134	Feed Regulating Dial Set Screw
146610	Presser Bar Lifting Lever Spring	504134	Feed Reverse Lever Hinge Stud Collar Set Screw
149031	Feed Dog, 19 teeth (22 teeth to the inch) (for 200A)	504134	Rotating Hook Shaft Oil Retaining Collar Set Screw (2)
154781	Arm Shaft (horizontal) Thrust Collar Set Screw (2)	504145	Oil Removing Tube Retaining Clamp Screw
154781	Presser Bar Lifting Lever Pin Set Screw	505001	Arm Dowel Pin (2)
154781	Thread Take-up Spring Regulator Set Screw	505151	Tension Releasing Lever Hinge Pin
154789	Bed Slide Spring Screw (2)	505152	Tension Releasing Lever Spring
154884	Bed Slide Spring	505317-452	Bed Slide Complete, Nos. 12431-452, 154884 and two 154789
154971	Face Plate Screw (3)	505356	Rotating Hook Bobbin Case Latch Spring
154983	Presser Bar Lifting Lever Connecting Rod Nut (2)	505575	Presser Bar Spring
272111	Feed Bar Connecting Link Oil Wick Clamp	505643	Presser Foot (spring hinged) Complete (for 200A)
409213	Bobbin Winder Spindle Thread Guard Wave Washer	505647	Rotating Hook Shaft Oil Filter Wick Holder
410026	Rotating Hook Bobbin Case Latch	505648	Rotating Hook Shaft Oil Filter Complete
410027	Rotating Hook Bobbin Case Latch Lever	505649	Presser Bar Bushing (lower)
410711	Arm Side Shield With 545770 and 545771	540406	Arm Shaft (horizontal) Flanged Bushing (front)
410713	Arm Top Cover Gasket	540450	Needle Bar Connecting Stud and Slide Block
410714	Bobbin Winder Complete, Nos. 410715, 410883, 541171, 544856, 544857 and two 544853	540476	Thread Take-up Crank Bearing Plate
410715	Bobbin Winder Spindle	540501-902	Needle Bar Crank
410718	Presser Bar Lifting Lever with 154781	540524	Needle Bar Bushing (lower) (for 200A)
410720	Feed Reverse Lever Hinge Stud Flanged Bushing	540525	Needle Bar Bushing (lower) (for 300A)
410721	Oil Pipe 410722 with 545846 and 545847	540528	Needle Bar Bushing (lower) Felt
410722	Oil Pipe	540533	Thread Take-up Spring Regulator O-ring
410725	Presser Bar Lifting Lever Connecting Rod	540534	Thread Take-up Spring Regulator Rubber Cap
410729	Feed and Feed Lifting Eccentric with two 545313	540536	Feed Bar Carrier
410731	Feed Rock Shaft Complete, Nos. 143236, 410732, 545160 and 545839	540537	Feed Bar Carrier 540536 with Three 504013
410732	Feed Rock Shaft	540538	Feed Bar Carrier Oil Wick (felt)
410733	Feed Regulating Plate	540539	Feed Lifting Rock Shaft
410744	Bobbin Winder Spindle Thread Guard	540540	Feed Lifting Rock Shaft Complete, Nos. 143236, 504111, 540539 and 545810
410878	Feed Reverse Lever Complete, Nos. 504051, 540623 to 540625, 540628, 540690, 549382 and 549383 (for 300A)	540541	Feed Lifting Rock Shaft Oil Wick (outer) (cotton)
410883	Bobbin Winder Bearing Housing Complete	540541	Feed Rock Shaft Oil Wick (outer) (cotton)
504002	Arm Shaft (horizontal) Flanged Bushing (back) Set	540544	Feed Bar Complete, Nos. 540537, 540538, 545789, 545791, 545808, 545987 and two 504103
504002	Arm Shaft (horizontal) Flanged Bushing (back) Set Screw	540546	Needle Bar Bushing (lower) 540525 with 545935 (for 300A)
504002	Arm Shaft (horizontal) Bushing (center) Set Screw	540547	Feed Bar Connecting Link Oil Wick (cotton)
504002	Arm Shaft (horizontal) Flanged Bushing (front) Set Screw	540549	Thread Guard (side of arm)
504002	Rotating Hook Shaft Bushing (back) Set Screw	540551	Arm Shaft (upright)
504002	Rotating Hook Shaft Bushing (front) Set Screw	540553	Oil Removing Pump (body)
504002	Thread Take-up Lever Link Hinge Stud Set Screw	540555	Oil Removing Pump Bracket
504007	Feed Lifting Rock Shaft Collar Set Screw (4)	540556	Oil Removing Pump Piston
504007	Feed Rock Shaft Collar Set Screw (2)	540557	Oil Removing Pump Piston Spring Bracket
504010-451	Arm Side Shield Screw	540561	Oil Removing Tube
504010-451	Oil Removing Pump Piston Spring Bracket Set Screw	540605	Arm Shaft (horizontal)
504010-451	Slack Thread Regulator Screw	540606	Arm Shaft (horizontal) and Needle Bar Crank with 504095, 504117, 504120 and 549230
504010-451	Thread Take-up Lever Guard Screw	540608	Arm Shaft (horizontal) Thrust Collar with two 154781
504010-451	Thread Take-up Lever Oil Guard Screw	540617	Bell Crank Complete
504013	Feed Bar Carrier Clamping Screw (2)	540623	Feed Regulating Dial with 504134, 540689 and 545492
504013	Feed Bar Hinge Pin Clamping Screw	540624	Feed Regulating Dial Lock Pin
504025	Bell Crank Bracket Set Screw (2)	540625	Feed Regulating Dial Lock Pin Spring
504029	Feed Rock Shaft Driving Frame Hinge Pin Set Screw (2)	540625	Oil Removing Pump Piston Spring
504047	Tension Stud Set Screw	540628	Feed Reverse Lever with 545046
504051	Feed Dog Screw (2)	540629	Feed Reverse Lever Complete, Nos. 504051, 540623, 540624, 540625, 540628, 540690, 549382 and 549383 (for 200A)
504051	Feed Regulating Dial Stopper Screw	540630	Feed Reverse Lever Hinge Stud
504063-451	Presser Foot Screw	540631	Feed Reverse Lever Hinge Stud Complete, Nos. 540630, 540547 and 545825
504064	Arm Screw (small)	540633	Feed Reverse Lever Hinge Stud Collar with 504134
504066	Arm Shaft (horizontal) Bevel Gear Set Screw (2)	540635	Feed Reverse Lever Hinge Stud Crank with 549028
504071	Oil Pump (centrifugal) (body) Screw (3)	540636	Feed Reverse Lever Hinge Stud Crank Connecting Link
504084	Rotating Hook Bobbin Case Holder Position Bracket Screw		
504086	Rotating Hook Bobbin Case Tension Regulating Screw		



NUMERICAL LIST OF PARTS FOR MACHINE 591D200A/D300A

PART NO.	DESCRIPTION	PART NO.	DESCRIPTION
540639	Feed Reverse Lever Spring	543419	Presser Foot (spring hinged) Complete (for 300A)
540641	Feed Reverse Lever Spring Retainer	543802-004	Bobbin Winder Spindle Thread Guard Retaining
540644	Feed Rock Shaft Crank with 545181 and 549183	543802-004	Bobbin Winder Spindle Thread Guard Retaining
540645	Feed Rock Shaft Driving Frame Complete, Nos. 540635, 540636, 540639, 540644, 540648, 540649, 540650, 540652, 544156, 548091, two each 540655, 540656, 540657 and 549288	543826	Ring
540648	Feed Rock Shaft Crank Connecting Rod with 545181 and two 545059	544156	Arm Screw (front) Washer (2)
540649	Feed Rock Shaft Crank Connecting Rod Pin	544156	Feed Reverse Lever Spring Screw
540650	Feed Rock Shaft Crank Pin	544203-008	Bobbin Winder Actuating Cam Set Screw
540652	Feed Rock Shaft Driving Frame with 545264 and two 545072	544204-001	Bobbin Winder Tension Set Screw
540653	Feed Rock Shaft Driving Frame Hinge Pin (back)	544212-002	Bobbin Winder Stop Latch Set Screw
540654	Feed Rock Shaft Driving Frame Hinge Pin (front)	544243	Bobbin Winder Bracket Screw Stud
540655	Feed Rock Shaft Driving Link (large) (2)	544244	Rotating Hook Screw (2)
540656	Feed Rock Shaft Driving Link (small) (2)	544368	Arm Screw (front) (2)
540657	Feed Rock Shaft Driving Link (small) Pin (2)	544745	Rotating Hook Bobbin Case Complete, Nos. 410026, 410027, 505356 and 544746
540660	Needle Bar Connecting Link	544746	Rotating Hook Bobbin Case with 504086, 504087 and 540767
540661	Needle Bar Connecting Link 540660 with 540450	544782	Face Plate Plug (small)
540662	Needle Bar Connecting Link Roller Bearing (2)	544847	Arm Top Cover and Bobbin Winder Complete, Nos. 409213, 410714, 410744, 542354, 543802-004, 544243, 544848, 544859, 544862, 544863, 544865 and 544866
540663	Needle Bar Thread Guard	544848	Arm Top Cover with 410713
540670	Presser Bar Lifting Lever Link	544853	Bobbin Winder Bearing (2)
540671	Tension Complete, Nos. 32758, 99691, 540672, 540682, 540683, 540684, 546928 and two 2102 (for 200A)	544856	Bobbin Winder Pulley
540672	Tension Releasing Disc	544857	Bobbin Winder Pulley Ring (rubber)
540673	Tension Releasing Lever (body) 545894 with 545057 and 540674	544859	Bobbin Winder Actuating Cam with 544203-008
540674	Tension Releasing Lever Segment	544862	Bobbin Winder Actuating Cam Stud
540676	Thread Take-up Lever with 52130	544863	Bobbin Winder Stop Latch with 544212-002
540677	Thread Take-up Crank (for 200A)	544865	Bobbin Winder Spring
540678	Thread Take-up Crank 540677 with 504118, 540661 and 540662 (for 200A)	544866	Bobbin Winder Stopper
540681	Rotating Hook Shaft Bushing (back)	544869	Machine Pulley with two 504119
540682	Tension Spring (for 200A)	544873-451	Thread Take-up Lever Guard
540683	Tension Stud 545898 with 545493 and 545404-451	544874	Face Plate with 544782, 544875 and 544876
540684	Tension Releasing Pin	544875	Face Plate Plug (large)
540685	Thread Take-up Crank (for 300A)	544876	Face Plate Gasket
540688	Thread Take-up Crank 540685 with 504118, 540661 and 540662 (for 300A)	544881	Needle Bar Connecting Stud with 549380
540689	Feed Regulating Dial Pin	545033	Arm Screw (back) (2)
540690	Feed Regulating Dial Stopper	545036	Arm Shaft (upright) Bevel Gear (upper) Set Screw
540696	Tension Complete, Nos. 32758, 99691, 125314, 540672, 540683, 540684, 546928 and two 2102 (for 300A)	545037	Hole Plug Screw
540698	Needle Bar (hollow) with 504112 (for 300A)	545037	Thread Take-up Crank Clamping Screw Hole Plug Screw
540702	Needle Bar (hollow) with 504112 (for 200A)	545038	Arm Shaft (horizontal) Flanged Bushing (front)
540703	Needle Bar Bushing (upper) Felt	545043	Oil Tube Cap Screw
540706	Arm Shaft (horizontal) Flanged Bushing (back)	545046	Feed Lifting Rock Shaft Crank (front) Clamping Screw
540707	Arm Shaft (horizontal) Flanged Bushing (back) Oil Seal	545047	Feed Reverse Lever Clamping Screw
540708	Arm Shaft (horizontal) Flanged Bushing (back) Ring	545049	Feed Reverse Lever Hinge Stud Cap Screw
540714	Oil Removing Tube Retaining Spring	545050	Oil Pump (centrifugal) Impeller Locking Screw
540716	Rotating Hook Shaft Bushing (front)	545051	Oil Pump (centrifugal) Screen Frame Screw (3)
540718	Machine Pulley Cap	545053	Oil Wick Holder Screw
540719	Oil Pipe Clamping Sleeve Nut	545054	Presser Bar Lifter Hinge Screw
540720	Arm Shaft (horizontal) Flanged Bushing (front) 540406 with Oil Drain Tube and 540722	545056	Presser Bar Lifting Lever Hinge Screw
540722	Arm Shaft (horizontal) Flanged Bushing (front) Oil Drain Tube Tape	545057	Feed Rock Shaft Flanged Bushing (front) Set Screw
540762	Thread Guide	545059	Tension Releasing Lever Screw
540767	Rotating Hook Bobbin Case Tension Spring	545059	Feed Lifting Rock Shaft Crank (back) Connecting Rod Cap Screw (2)
540771	Needle Bar Bushing (lower) Thread Eyelet (for 200A)	545072	Feed Rock Shaft Crank Connecting Rod Cap Screw (2)
541170	Bobbin Winder Tension Nut	545099	Feed Rock Shaft Driving Link (small) Pin Set Screw (2)
541171	Bobbin Winder Pulley Lock Nut	545150	Presser Bar Guide Bracket Clamping and Tension Releaser Screw
542354	Bobbin Winder Stopper Snap Ring	545181	Feed Rock Shaft Oil Plug Screw
543363	Oil Wick Holder and Pipe (for 200A)	545181	Feed Rock Shaft Crank Connecting Rod Pin Set Screw
543364	Oil Wick Holder and Pipe (for 300A)	545183	Feed Reverse Lever Spring Retainer Screw
543365	Oil Wick Holder Complete (for 200A)	545239	Oil Removing Pump Bracket Set Screw (3)
543366	Oil Wick Holder Complete (for 300A)	545264	Feed Rock Shaft Driving Frame Spring Stud
543367	Thread Take-up Lever Link	545313	Feed and Feed Lifting Eccentric Set Screw (2)
543368	Thread Take-up Lever Link Hinge Stud	545403	Presser Bar Guide and Pressure Regulating Thumb Screw Lock Nut
543369	Thread Take-up Lever Link Hinge Stud 543368 with 543370	545404-451	Tension Regulating Thumb Nut Lock Nut
543370	Thread Take-up Lever Link Hinge Stud Oil Wick (cotton)	545492	Feed Regulating Nut
543371	Oil Removing Tube Retaining Clamp	545493	Tension Regulating Thumb Nut
543416	Thread Take-up Complete, Nos. 540662, 540676, 540678, 543367 and 543369 (for 200A)	545754	Arm Shaft (upright) Bevel Gear (upper) Set Screw
543417	Thread Take-up Complete, Nos. 540662, 540676, 540688, 543367 and 543369 (for 300A)	545755	Hole Plug Screw Gasket
		545755	Thread Take-up Crank Clamping Screw Hole Plug Screw Gasket
		545757	Arm Shaft (horizontal) Bevel Gear with two 504066
		545758	Arm Shaft (horizontal) Bushing (center)
		545761	Arm Shaft (horizontal) Flanged Bushing (front) Oil Tube
		545764	Arm Shaft (upright) Bevel Gear (lower) Right Hand Spiral with two 504101