

**PRESSER FEET FOR SINGER**

SINGLE NEEDLE DROP FEED LOCKSTITCH MACHINES (CLASSES: 31, 44, 95, 96, 191D, 195K, 196K, 241, 245, 251, 281, 331K, 366K, 400W, 451K, 491, 591D, 600W, 660A, 770, 771, 1300 & CENTURION 121D)

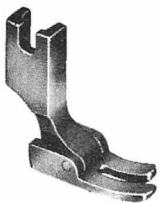

**REGULAR**

# 24983 (# 62927) (# 161066)  
 (# 505643) (# 540739)  
 # 24983T Teflon Base  
 # 26231 Hinged Foot Spring

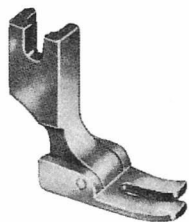

**REGULAR**

# 24983SW (# 24545SW)  
 Swiss

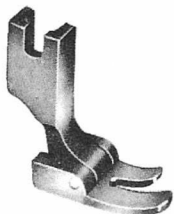

**WIDE**

# 19336  
 # 19336T Teflon Base



**EXTRA WIDE**

# 127233 (# 127234)  
 # 127233T Teflon Base



**DOUBLE TOE EVEN**

# 12144H  
 # 12144HT Teflon Base



**NARROW**

# 142058N  
 # 142058NT Teflon Base

**FOOT FOR SETTING COLLAR BANDS TO SHIRTS**

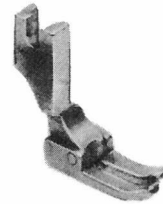

# 149027

Suggested for use with # 149023LG Plate and # 149021 Feeder

**FOOT FOR PERMANENT PRESS FABRICS**



# 52427

**PLAIN FEET**



# 12142 (Hard)  
 # 12142S (Soft)



**DOUBLE TOE EVEN**

# 12144 (Hard)  
 # 12144S (Soft)



**HALF FOOT**

# 25983



**SINGLE TOE**

# 12143

**LEFT CORDING FEET**

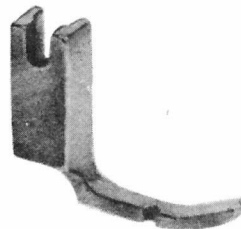

**NARROW**

# 31358N  
 # 31358NT Teflon Base



**WIDE**

# 31358W  
 # 31358WT Teflon Base

**RIGHT CORDING FEET**



**NARROW**

# 12435N  
 # 12435NT Teflon Base



**WIDE**

# 12435W  
 # 12435WT Teflon Base

**PRESSER FEET FOR SINGER (Continued)**

**LEFT HINGED CORDING FEET**

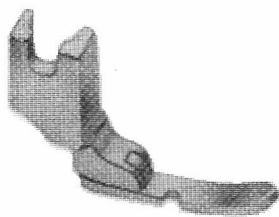

**NARROW**

# 31358HN  
# 31358HNT Teflon Base

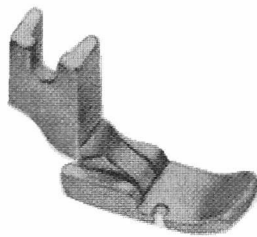

**WIDE**

# 31358HW  
# 31358HWT Teflon Base

**RIGHT HINGED CORDING FEET**

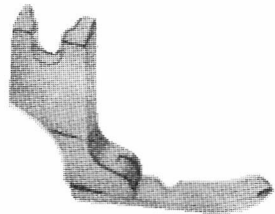

**NARROW**

# 12435HN  
# 12435HNT Teflon Base



**WIDE**

# 12435HW  
# 12435HWT Teflon Base

**HINGED ZIPPER FEET**

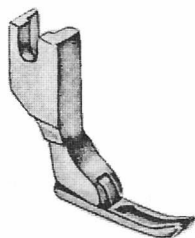

**SPLIT HINGE**

# 40322SH  
# 40322SHT Teflon Base

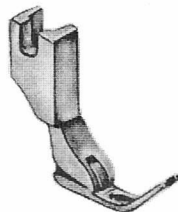

**LIN-O-VEL**

**SPLIT HINGE WITH TURNED FRONT**

# 165010H  
# 165010HT Teflon Base

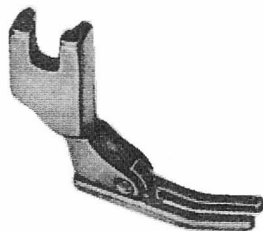

**MEDIUM SPLIT HINGE**  
# 121946

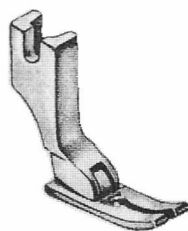

**WIDE SPLIT HINGE**

# 142058 (# 142059)  
# 142058T Teflon Base

**ZIPPER FEET**

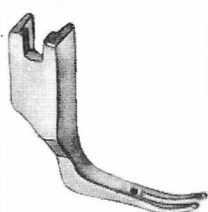

**SPLIT**

# 165010  
# 165010T Teflon Base

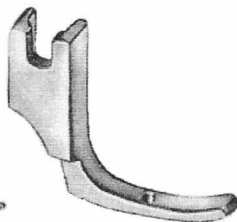

**HOLE IN CENTER**

# 40322  
# 40322T Teflon Base

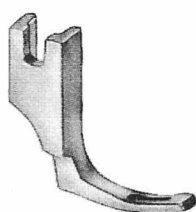

**CLOSED SPLIT**

# 40322CS  
# 40322CST Teflon Base

**RIGHT QUILTER ZIPPER FOOT**

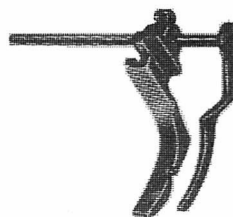

**# S523**

Helps to make uniform, even stitches on either side of zipper.

**WHEN ORDERING . . .  
PLEASE USE THE PART  
NUMBERS EXACTLY AS  
SHOWN IN THIS  
CATALOG (INCLUDING  
DASHES).**

**ADJUSTABLE LEFT AND RIGHT CORDING FEET**



**REGULAR**  
# 4351

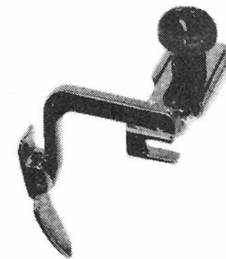

**HINGE**  
# 4351H

**HINGED QUILTER FOOT**

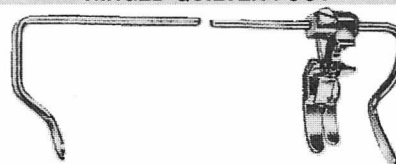

Excellent for all type patch settings (Includes Left and Right Gauges)  
# S521

**PARTS AVAILABLE SEPARATELY:**

- # S521GL Left Gauge for Quilter Foot
- # S521GR Right Gauge for Quilter Foot
- # HQ10 Spring Screw for Quilter Foot
- # HQ15 Quilter Foot Guider Screw
- # HQ20 Hinged Quilter Foot Spring

**RAISING (Edge) FEET**



- # 12463 1/32 Gauge Size: 1/32"
- # 12463 1/16 Gauge Size: 1/16"
- # 12463 1/8 Gauge Size: 1/8"
- # 12463 3/16 Gauge Size: 3/16"
- # 12463 1/4 Gauge Size: 1/4"
- # 12463 5/16 Gauge Size: 5/16"
- # 12463 3/8 Gauge Size: 3/8"
- # 12463 1/2 Gauge Size: 1/2"

**ADJUSTABLE HINGED RAISING FOOT**

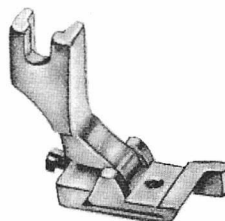

**# S592**

Makes any size edge from 1/32" to 1/4"

**FOR PRESSER FEET  
NOT LISTED HERE  
REFER TO MACHINE  
CLASS LISTINGS.**

**LEFT HINGED RAISING FEET**



- |                                  |                                  |
|----------------------------------|----------------------------------|
| # L12463H 1/32 Gauge Size: 1/32" | # L12463H 3/16 Gauge Size: 3/16" |
| # L12463H 1/16 Gauge Size: 1/16" | # L12463H 1/4 Gauge Size: 1/4"   |
| # L12463H 3/32 Gauge Size: 3/32" | # L12463H 5/16 Gauge Size: 5/16" |
| # L12463H 1/8 Gauge Size: 1/8"   | # L12463H 3/8 Gauge Size: 3/8"   |
|                                  | # L12463H 1/2 Gauge Size: 1/2"   |

**RIGHT HINGED RAISING FEET**

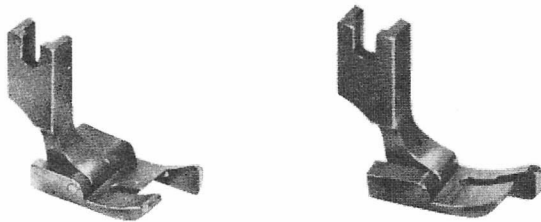

- |                                 |   |
|---------------------------------|---|
| # 12463H 1/32 Gauge Size: 1/32" | # 12463HT 1/16 Teflon Base, Gauge Size: 1/16" |
| # 12463H 1/16 Gauge Size: 1/16" | # 12463HT 1/8 Teflon Base, Gauge Size: 1/8"   |
| # 12463H 3/32 Gauge Size: 3/32" | # 12463HT 3/16 Teflon Base, Gauge Size: 3/16" |
| # 12463H 1/8 Gauge Size: 1/8"   | # 12463HT 1/4 Teflon Base, Gauge Size: 1/4"   |
| # 12463H 3/16 Gauge Size: 3/16" | # 12463HT 5/16 Teflon Base, Gauge Size: 5/16" |
| # 12463H 1/4 Gauge Size: 1/4"   | # 12463HT 3/8 Teflon Base, Gauge Size: 3/8"   |
| # 12463H 5/16 Gauge Size: 5/16" | # 12463HT 1/2 Teflon Base, Gauge Size: 1/2"   |
| # 12463H 3/8 Gauge Size: 3/8"   |   |
| # 12463H 1/2 Gauge Size: 1/2"   |   |

**ADJUSTABLE GUIDE FOOT**

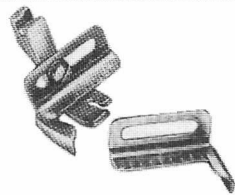

# S524

**GUIDES AVAILABLE SEPARATELY:**

- # S520R (Right)
- # S520L (Left)

**SUPERIOR EDGE STITCH FOOT**

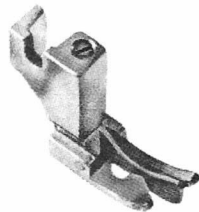

# SM20 Gauge Size: 1/32" With Adjustable Tension Spring For Different Weight Materials

**TOP STITCH GUIDE FEET**

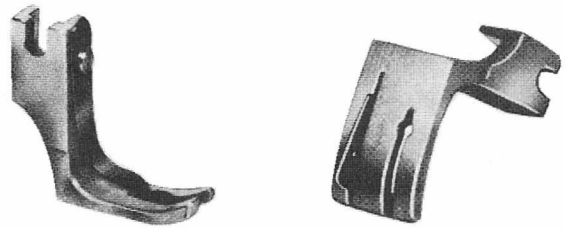

- |                                |                                |
|--------------------------------|--------------------------------|
| # 36465 1/32 Gauge Size: 1/32" | # 36465 1/4 Gauge Size: 1/4"   |
| # 36465 1/16 Gauge Size: 1/16" | # 36465 5/16 Gauge Size: 5/16" |
| # 36465 3/32 Gauge Size: 3/32" | # 36465 3/8 Gauge Size: 3/8"   |
| # 36465 1/8 Gauge Size: 1/8"   | # 36465 1/2 Gauge Size: 1/2"   |
| # 36465 3/16 Gauge Size: 3/16" |                                |

**TOP STITCH SPRINGS**

- |   |
|---|
| # 36464 1/32 For Gauge Sizes: 1/32"; 1/16"; 3/32"; 1/8" |
| # 36464 3/16 For Gauge Sizes: 3/16"; 1/4"; 5/16"        |
| # 36464 3/8 For Gauge Size: 3/8"                        |
| # 36464 1/2 For Gauge Size: 1/2"                        |

**QUILTER FEET**

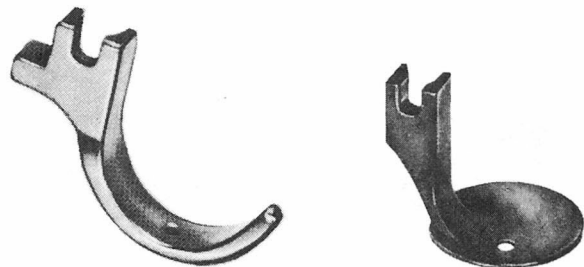

# 160342

# QS1

**9 GAUGE PATENT FOOT**

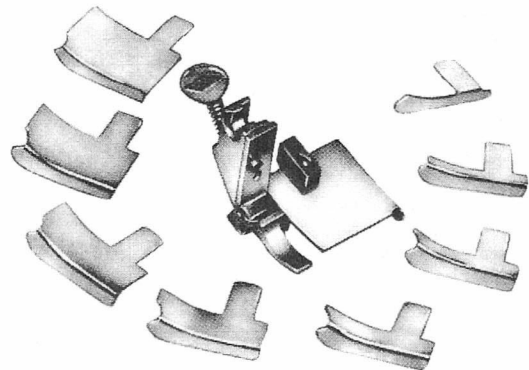

# 9G

9 Gauge Patent Foot

Nine separate removable guides from 1/16" to 1". Convenient "Rear Angle Screw" insures positive slip proof locking. "Flat Front" construction on all gauges keeps cloth flat while in operation. Comes in one complete unit.

**EXTRA GAUGES FOR 9 GAUGE PATENT FOOT**

- |                             |                           |
|-----------------------------|---------------------------|
| # 9G 1/16 Gauge Size: 1/16" | # 9G 3/8 Gauge Size: 3/8" |
| # 9G 1/8 Gauge Size: 1/8"   | # 9G 1/2 Gauge Size: 1/2" |
| # 9G 3/16 Gauge Size: 3/16" | # 9G 5/8 Gauge Size: 5/8" |
| # 9G 1/4 Gauge Size: 1/4"   | # 9G 3/4 Gauge Size: 3/4" |
|                             | # 9G 1 Gauge Size: 1"     |

**FOR OUR COMPLETE  
LINE OF SCREWS  
REFER TO PAGES 103-134.**

**PRESSER FEET FOR SINGER (Continued)**

**PATENT FOOT  
with 3 Gauges**

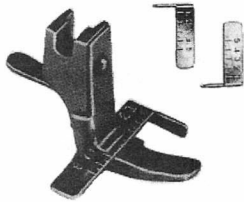

# 35137

**COMBINATION SHIRRING AND  
STITCHING FOOT**

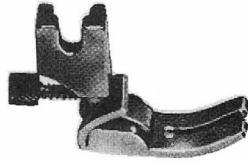

# S952

**AVAILABLE SEPARATELY:**  
# S952SC Screw  
# S952SP Spring

**FRENCH PIPING FEET**

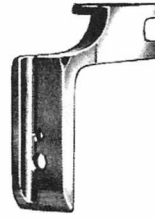

# 26650L (Left)  
# 26650R (Right)

**DOUBLE GROOVE FRENCH  
PIPING FOOT**

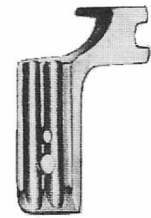

# 26650DG (Double Groove)

**SHIRRING FEET**



**WIDE  
HIGH STEP**  
# 120828H

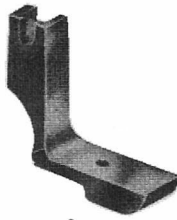

**WIDE  
REG. STEP**  
# 120828



**NARROW  
REG. STEP**  
# 120828N

**TURNED UP HINGED PIPING FEET**

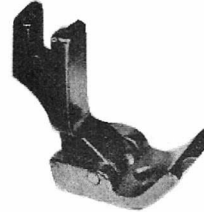

**LEFT**  
# L36069H 1/8 Gauge Size: 1/8"  
# L36069H 3/16 Gauge Size: 3/16"  
# L36069H 1/4 Gauge Size: 1/4"

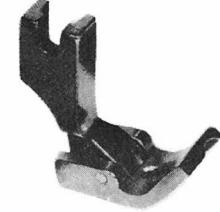

**RIGHT**  
# R36069H 1/8 Gauge Size: 1/8"  
# R36069H 3/16 Gauge Size: 3/16"  
# R36069H 1/4 Gauge Size: 1/4"

**ADJUSTABLE SHIRRING FOOT**

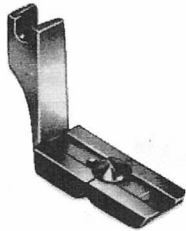

**ADJUSTABLE  
HIGH & REG. BLOCK**  
# S950

**COMPENSATING SHIRRING  
FOOT with Edge Guide**



# 270533  
(FOR 400W; 400W30, 31)

**CORDING & PIPING FEET COMBINATIONS**



**LEFT COMBO**

# 31358L 1/8 Gauge Size: 1/8"  
# 31358L 3/16 Gauge Size: 3/16"  
# 31358L 1/4 Gauge Size: 1/4"  
This foot is a combination of a RIGHT PIPING Foot and a LEFT CORDING Foot.

**ATTACHMENT SHIRRER FOOT**

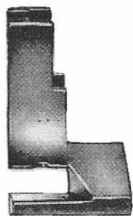

# S207  
Made of Forged Steel.  
Specially Designed.  
Suitable for Various Sizes.

**DOUBLE GAUGE PIPING FEET**

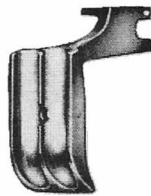

# 36069DG 1/8 Double Gauge Size: 1/8"  
# 36069DG 3/16 Double Gauge Size: 3/16"  
# 36069DG 1/4 Double Gauge Size: 1/4"



**RIGHT COMBO**

# 12435R 1/8 Gauge Size: 1/8"  
# 12435R 3/16 Gauge Size: 3/16"  
# 12435R 1/4 Gauge Size: 1/4"  
This foot is a combination of a LEFT PIPING Foot and a RIGHT CORDING Foot.

**LEFT AND RIGHT PIPING FEET**

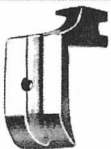

**LEFT**

# 36069L 1/16 Left Gauge Size: 1/16"  
# 36069L 1/8 Left Gauge Size: 1/8"  
# 36069L 3/16 Left Gauge Size: 3/16"  
# 36069L 1/4 Left Gauge Size: 1/4"  
# 36069L 3/8 Left Gauge Size: 3/8"  
# 36069L 1/2 Left Gauge Size: 1/2"



**RIGHT**

# 36069R 1/16 Right Gauge Size: 1/16"  
# 36069R 1/8 Right Gauge Size: 1/8"  
# 36069R 3/16 Right Gauge Size: 3/16"  
# 36069R 1/4 Right Gauge Size: 1/4"  
# 36069R 3/8 Right Gauge Size: 3/8"  
# 36069R 1/2 Right Gauge Size: 1/2"

**HINGED NYLON FOOT**



# S710

**HINGED BLANK FOOT**

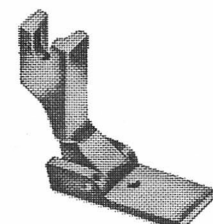

# S500 Regular Hole in Center (Soft)

HINGED LINING FEET



# 12144HLD  
# 12144HLDT Teflon Base



# 12144HLB Regular Turned Up Front  
# 12144HLBT Teflon Base

VELVET FEET

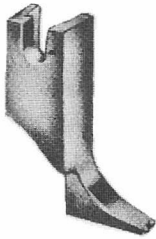

SHORT TOE  
# S530S



LONG TOE  
# S531L Upturn

BLANK FOOT

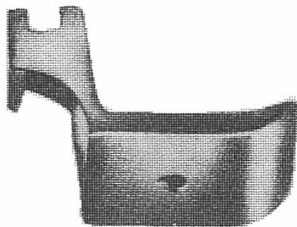

# S801 Wide Hole in Center (Soft)

BLANK FOOT

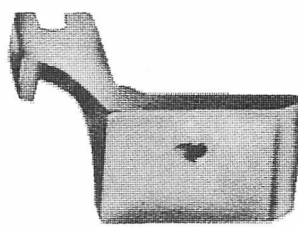

# S802 Wide Hole to Left (Soft)

BLANK FOOT

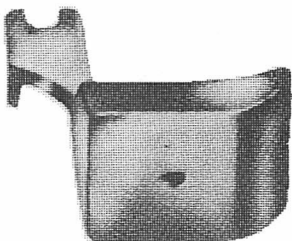

# S804 Extra Wide Hole in Center (Soft)

BLANK FOOT

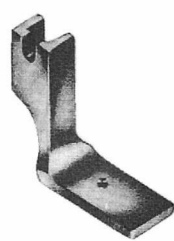

# S400 Regular Hole in Center (Soft)

BLANK FOOT

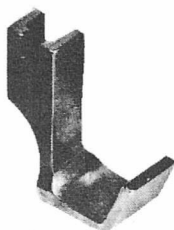

# S402 Regular Turned Up Front

BLANK FOOT

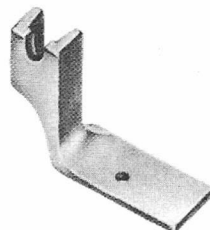

# S401 Regular Hole to Left (Soft)

HINGED EDGE CUTTER FEET

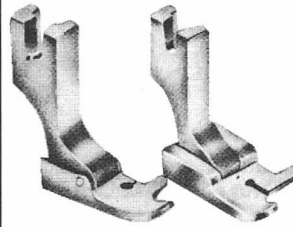

REGULAR

- # 127034H 1/8 (# 147253 1/8)  
Gauge Size: 1/8"
- # 127034H 3/16 (# 147254 3/16)  
Gauge Size: 3/16"
- # 127034H 1/4 (# 147254 1/4)  
Gauge Size: 1/4"
- # 127034HT 1/8 Teflon Base,  
Gauge Size: 1/8"
- # 127034HT 3/16 Teflon Base,  
Gauge Size: 3/16"
- # 127034HT 1/4 Teflon Base, Gauge  
Size: 1/4"

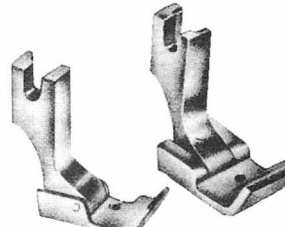

BLANK

- # 127034HB 1/8 Gauge Size: 1/8"
- # 127034HB 3/16 Gauge Size: 3/16"
- # 127034HB 1/4 Gauge Size: 1/4"

HINGED TUBE FEET



1/4"  
CENTER,  
RIGHT  
OR LEFT

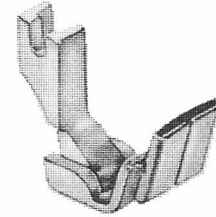

1/2"  
CENTER,  
RIGHT  
OR LEFT

- # S10C 1/4 Center 1/4"
- # S10R 1/4 Right 1/4"
- # S10L 1/4 Left 1/4"

- # S10C 1/2 Center 1/2"
- # S10R 1/2 Right 1/2"
- # S10L 1/2 Left 1/2"

HINGED TUBE FEET AVAILABLE IN OTHER SIZES:

- # S10C 1/8 Center 1/8"
- # S10C 3/16 Center 3/16"
- # S10C 3/8 Center 3/8"
- # S10R 3/8 Right 3/8"
- # S10L 3/8 Left 3/8"
- # S10C 5/8 Center 5/8"
- # S10R 5/8 Right 5/8"
- # S10L 5/8 Left 5/8"
- # S10L 5/8 Left 5/8"
- # S10C 3/4 Center 3/4"
- # S10R 3/4 Right 3/4"
- # S10L 3/4 Left 3/4"
- # S10C 1 Center 1"
- # S10R 1 Right 1"
- # S10L 1 Left 1"

TUBES AVAILABLE SEPARATELY:

- # TU 1/8 Tube Size: 1/8"
- # TU 3/16 Tube Size: 3/16"
- # TU 1/4 Tube Size: 1/4"
- # TU 3/8 Tube Size: 3/8"
- # TU 1/2 Tube Size: 1/2"
- # TU 5/8 Tube Size: 5/8"
- # TU 3/4 Tube Size: 3/4"
- # TU 1 Tube Size: 1"

1/2" SEAM BINDING FOOT  
with Guide



# S532

FOR PRESSER FEET  
NOT LISTED HERE  
REFER TO MACHINE  
CLASS LISTINGS.

**PRESSER FEET FOR SINGER (Continued)**

**ADJUSTABLE TUBE FOOT**

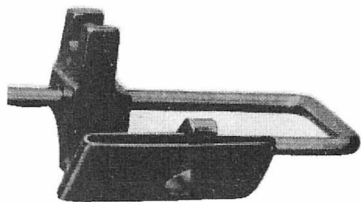

**#S533**

Complete with 2 Shells. Adjustable in width (1/8" to 1" and 1" to 2") and Stitch Location at no extra cost.

**EXTRA TUBES AVAILABLE**

**#S5331** For 1/8" to 1"

**#S5332** For 1" to 2"

**SINGLE FOLD HEMMER FOOT**



**#490357** 1/4 Upturn

**SINGLE FOLD HEMMER FOOT**



**#490355** 1/4 Downturn

**DELUXE ADJUSTABLE TAPE FOOT**



**#S534**

Designed for accuracy and uniformity. Has an adjustable guide for running ribbons, bindings, etc. Adjustable to any width up to 1". Stitch can be regulated to any position on binding.

**SINGLE FOLD HEMMER FEET**

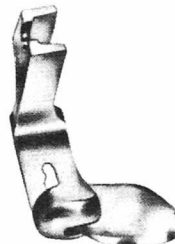

**#490356** 1/4 Reverse Downturn  
**#490356** 3/16 Reverse Downturn

**FOR OUR COMPLETE  
 LINE OF SCREWS  
 REFER TO PAGES 103-134.**

**BALL HEMMER FEET (DOUBLE FOLD)**

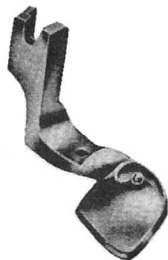

Mouth opens to allow heavy portions of material and seams to pass through freely.

- #490358** 1/32 Gauge Size: 1/32"
- #490358** 1/16 Gauge Size: 1/16"
- #490358** 1/8 Gauge Size: 1/8"
- #490358** 3/16 Gauge Size: 3/16"
- #490358** 1/4 Gauge Size: 1/4"

**SCROLL SINGER TYPE HEMMER FEET**

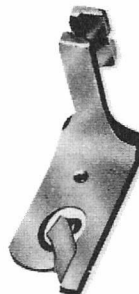

- #160344** Gauge Size: 1/16"
- #120938** Gauge Size: 3/32"
- #120803** Gauge Size: 1/8"
- #120804** Gauge Size: 5/32"
- #120805** Gauge Size: 3/16"
- #120940** Gauge Size: 1/32"
- #120806** Gauge Size: 1/4"
- #120807** Gauge Size: 3/16"

**WIRE HEMMER FEET (DOUBLE FOLD)**

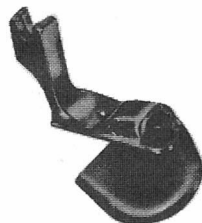

Mouth opens to allow heavy portions of material and seams to pass through freely.

- #490360** 1/32 Gauge Size: 1/32"
- #490360** 1/16 Gauge Size: 1/16"
- #490360** 3/32 Gauge Size: 3/32"
- #490360** 1/8 Gauge Size: 1/8"
- #490360** 3/16 Gauge Size: 3/16"
- #490360** 1/4 Gauge Size: 1/4"

**TOP STITCH JOINER FEET**



Single downturn fold on one ply and top stitched and joined to another ply in one operation.

- #H5020** 3/16 Gauge Size: 3/16"
- #H5020** 1/4 Gauge Size: 1/4"

**SHIRRING FOOT**



**#270195**

**SPRING HEMMER FEET (DOUBLE FOLD)**

★ With Seam Opening Spring

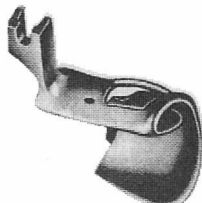

Mouth opens to allow heavy portions of material and seams to pass through freely.

- #490359** 1/32 Gauge Size: 1/32"
- #490359** 1/16 Gauge Size: 1/16"
- #490359** 1/8 Gauge Size: 1/8"
- #490359** 3/16 Gauge Size: 3/16"
- #490359** 1/4 Gauge Size: 1/4"

**ELASTIC SHIRRING FEET WITH ADJUSTABLE TENSIONS**

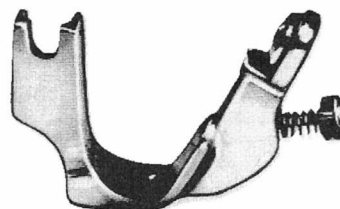

- #S537** 1/8 Size: 1/8"
- #S537** 3/8 Size: 3/8"
- #S537** 3/16 Size: 3/16"

- #S537** 1/2 Size: 1/2"
- #S537** 1/4 Size: 1/4"

**BINDER FEET**



**REGULAR**  
# 12142C

**EXTRA WIDE**  
# 12142XW

**ALSO AVAILABLE:**  
SPECIAL CUT OUT TO FIT BINDERS  
# 12142C 3/4 Cut Out 3/4"  
# 12142C 7/8 Cut Out 7/8"  
# 12142C 1 Cut Out 1"  
# 12142C 1 1/8 Cut Out 1 1/8"  
# 12142C 1 1/4 Cut Out 1 1/4"  
# 12142C 1 3/8 Cut Out 1 3/8"  
# 12142C 1 1/2 Cut Out 1 1/2"

**HINGED BINDER FOOT WITH ADJUSTMENT SCREW**



# 12142AHB

AVAILABLE SEPARATELY:  
# 12142AHBN Nut For  
# 12142AHB Binder Foot

**HINGED BINDER FOOT WITH ADJUSTMENT SCREW**



# 12142AHBNF For Needle Feed Machines

**COMPENSATING BINDER FEET**

★ Fits Any Set-In-Binder

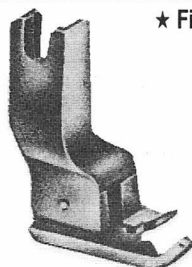

These feet compensate for any variation of thickness and feed on both sides. For faster feeding, perfectly even binding, less feeder marks, flatter garments.

# 601 for 3/4" or 7/8" Binding  
# 602 for 1" or 1 1/8" Binding

# 604 for 1 1/4" or wider Binding

**EDGE GUIDE HEMMING FOOT**

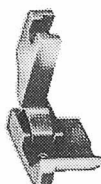

**SMALL**  
# S538 for Hems up to 1/4"



**MEDIUM**  
# S539 for Hems up to 1/2"



**LARGE**  
# S540 for Hems up to 1"

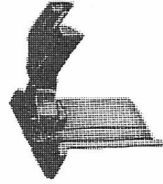

**EXTRA LARGE**  
# S541 for Hems up to 1" and over

FOR USE ON HEMS WHEN A MORE UNIFORM STITCHING MARGIN IS REQUIRED

**HEMMING FEET**

Available in 3 Size Widths



1/2"

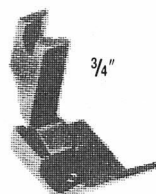

3/4"



1"

# S542 1/2 Size: 1/2" # S542 3/4 Size: 3/4" # S542 1 Size: 1"  
The turned up toe permits hemmers and folders to run through freely without pleating or wrinkling.

**REVERSE EDGE GUIDE HEMMING FOOT**



# SR1

For use on Hems when a more uniform stitching margin is required.

**HINGED HEMMING FOOT**

Used with Hemmers up to 1/4"



# S545

An excellent foot, used in conjunction with hemmers and other attachments. Helps keep the fold of the material in place.

**COMPENSATING HEMMING FEET**



**NARROW**

# S543 Used with Hemmers & Folders up to 3/4"

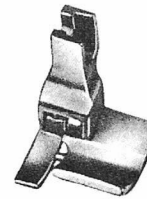

**WIDE**

# S544 Used with Hemmers & Folders up to 1 1/4"

Compensates for any variation of material and feeds on both sides. For faster feeding, perfect hemming and folding. Garment is flatter—less puckering and curling.

**COMPENSATING FOOT**

With Double Spring Action and Replaceable Screws



1/32" GAUGE

# 21R (# 143219) Right  
# 22L (# 143215) Left  
# 23 Double

# 21RT Right, Teflon Base  
# 22LT Left, Teflon Base  
# 23DT Double, Teflon Base



1/32" GAUGE (NARROW)

# 210 Right  
# 220 Left  
# 230 Double



1/16" GAUGE

# 211 Right  
# 221 Left  
# 231 Double  
# 221LT Left, Teflon Base

**AVAILABLE SEPARATELY:**

# CFS1 Replacement Screw (1/32" Thru 1/16" Gauge) # CSP1 Replacement Spring for # 210  
# CFS5 Replacement Screw for # 210 # CSP2 Replacement Spring

**PRESSER FEET FOR SINGER (Continued)**

**COMPENSATING FEET**



**1/8" GAUGE**

# 212 Right  
# 222 Left

# 222LT  
Left Compensating Foot 1/8" (Teflon)



**3/16" GAUGE**

# 213 Right  
# 223 Left  
# 213RT Right, Teflon Base  
# 223LT Left, Teflon Base



**1/4" GAUGE**

# 214 Right  
# 224 Left  
# 214RT Right, Teflon Base

**AVAILABLE SEPARATELY:**

# CFS2 Replacement Screw (1/8" Gauge) # CFS4 Replacement Screw (1/4" Gauge)  
# CFS3 Replacement Screw (3/16" Gauge) # CSP2 Replacement Spring

**LARGE SIZE COMPENSATING FEET**  
With Double Spring Action and Replaceable Screws

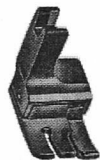

# 215R 5/16" Right (Illustrated)  
# 225L 5/16" Left

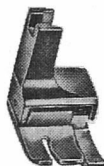

# 216R 3/8" Right (Illustrated)  
# 226L 3/8" Left

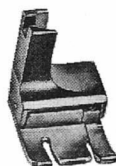

# 218R 1/2" Right (Illustrated)  
# 228L 1/2" Left

**AVAILABLE SEPARATELY:**

# CFS7 Replacement Screw for # 215R and # 225L  
# CFS6 Replacement Screw for # 216R and # 226L  
# CFS8 Replacement Screw for # 218R and # 228L

**COMPENSATING FEET WITH NEEDLE HOLE**  
With Double Spring Action and Replaceable Screws. Needle Hole Improves Operator's Control Over Stitching at High Speeds.



# R22-1 1/32" Left

Specially  
Designed  
For  
Understitching



# 211H 1/32" Right # 221H 1/16" Left  
# 22HL 1/32" Left # 212H 1/8" Right  
# 211H 1/16" Right # 222H 1/8" Left

**DUAL COMPENSATING RAISING FEET (COMPENSATING FEET WITH STRIP GAUGE)**

These feet enable operator to obtain Two Different Stitching margins without changing Presser Foot.  
★ TWO OPERATIONS WITH THE SAME FOOT ★

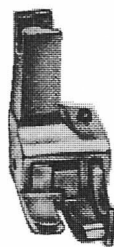

OPERATION "1"



OPERATION "2"

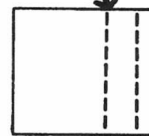

# 21-14 (1/32" Right) With 1/4" Right Strip Gauge  
# 21-15 (1/32" Right) With 5/16" Right Strip Gauge  
# 211-14 (1/16" Right) With 1/4" Right Strip Gauge  
# 211-15 (1/16" Right) With 5/16" Right Strip Gauge

EACH FOOT SUPPLIED WITH ALLEN WRENCH

**ALSO AVAILABLE:**

# 21-14SC Screw  
# 21-14WR Wrench

**TAPE EDGE SHIRRING FEET**



REGULAR  
# P5R



WIDE  
# P5W

**TOP STITCH FOOT FOR COLLAR SCORING**

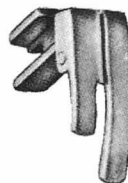

# 147391 With Special Groove  
Suggested for use with # 52032LG  
(# 147154) Plate and # 149006 Top  
Stitch Feeder with Special Prong

**FOOT FOR COLLARS & BACK BINDING**



# 147308  
Suggested for use with # 147309 Plate  
and # 147305 Feeder

**HINGED FOOT FOR CURTAIN WORK**

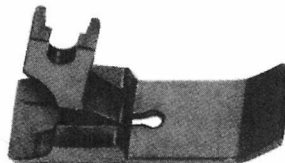

# 143168

FOR OUR **METRIC**  
**CONVERSION TABLE**  
REFER TO PAGE 90 OR  
610.

**CROWS NEST FOOT**



# NP-37

**DESIGNED FOR UNDER-TRIM MACHINES**

Foot is designed to cut the top thread cleanly and hold it in place for the next garment thus eliminating skipped starting stitches (when installing remove thread wiper).

**ALSO AVAILABLE**

- # NP-37B Replaceable Bottom For Crows Nest Foot
- # NP-37S Replaceable Screw For Crows Nest Foot

**AUTOMATIC CHAIN CUTTING FEET WITH CARBIDE BLOCK**

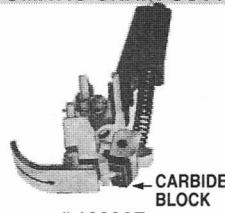

# 160997

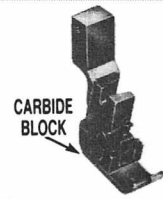

# 160929

**REPLACEMENT PARTS:**

- # 121998 Foot Shoe Only
- # 121999 Shoe Presser Spring
- # 160709 Carbide Knife Body
- # 121996 Block Pressure Spring

**ETCHING (DARNING) FOOT**

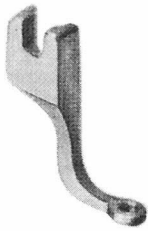

# 26936

**KISSABLE ZIPPER FOOT**

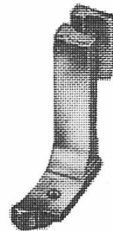

# SK223

**INVISIBLE HINGED ZIPPER FOOT**

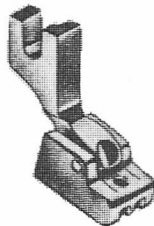

# S518

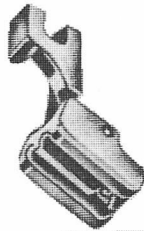

**SPK ROLLER FOOT**

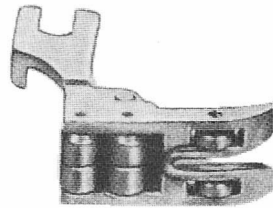

# SPK3

Recommended with use of # SPK1 Needle Plate and # SPK2 Feeder

**NYLON ROLLER FOOT**



# S517

Designed to stitch Rubber or Plastic Coated or Laminated materials.

**ALSO AVAILABLE:**

- # S519 for 111W Needle Feed Machines

**CHAIN CUT-OFF FEET**

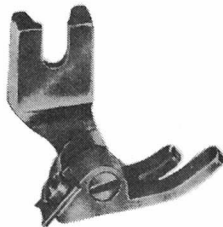

# S536 Style "A"



# 127260

**ALSO AVAILABLE:**

- # 127259 Knife for # 127260 Foot.

**SUPERIOR CHAIN CUT-OFF FOOT**

The Finest Thread Cutter Foot Ever Developed



KNIFE CUTS THREAD

# S535



SPRING HOLDS THREAD

Sturdily constructed for long lasting use. Cuts and holds thread every time. Operation takes place with regular sewing motion. Thread passes through slot under spring. Cuts and holds at knife position.

**REPLACEMENT PARTS:**

- # S5351 Screw, # S5352 Knife

**ADJUSTABLE ROLLER FOOT**



# S548

Can be used for general kinds of tailoring sewing machines with no additional equipment. By adjusting height of spring, it is adapted for various thickness, kinds, and layers of Foam Laminated fabrics.

**SUPERIOR DELUXE ROLLER PRESSER FOOT**

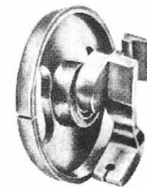

# SDRF

- ★ Designed for surfaces that cannot be oiled.
- ★ Eliminates the use of oil and oil pads.
- ★ Stops gathering and uneven stitches.
- ★ Excellent for the belt and leather trade.

**ROLLER FOOT # 62861  
COMPLETE WITH PRESSER BAR # 19464  
FOR Classes: 31-17, 31-18 & 31-29**



COMPLETE SET # S194

**ALSO AVAILABLE SEPARATELY:**

- # 62861 Roller Foot
- # 19464 Presser Bar

**PRESSER FEET FOR SINGER (Continued)**

**ROLLER PRESSER FEET (COMPLETE)**

For Laminated Fabrics, Foam Rubber, Nylon, Plastics and Leather

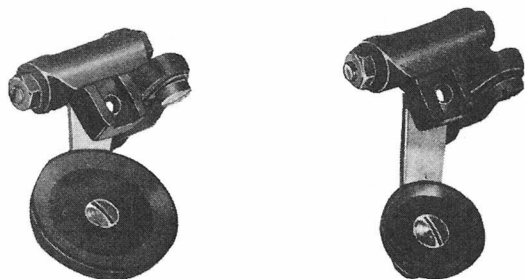

**SERRATED ROLLERS**

**LARGE**

# 12267 (# 16100) Complete With # 1898 Roller, Screw & Nut

**SMALL**

# 12264 Complete With # 1895 Roller, Screw & Nut

RECOMMENDED WITH USE OF # 12438 SINGLE ROW NEEDLE PLATE AND # 12436 (# 149436) FEEDER

**AVAILABLE SEPARATELY:**  
# 2205 Spring For # 12264 & # 12267 Roller Feet

**HINGED OIL CUP FOOT**

For Sewing Plastic, Foam, Polyethylene, Rubber Backed and Other Materials Not Sewable With Regular or Teflon Feet.

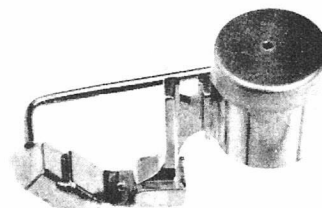

# S546

**NYLON RING FOOT, COMPLETE**

For Preventing Plastics, Coated Materials, Leathers, Etc. From Sticking to Foot. Allows For Smooth Sewing on Difficult Fabrics.

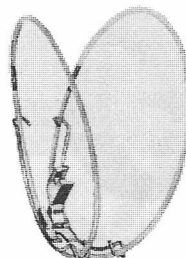

# S515

Ring rotates as material passes under foot. Action eliminates friction.

**AVAILABLE SEPARATELY:**  
# S516 Nylon Hoops

**SPRING ACTION ROLLER FOOT**

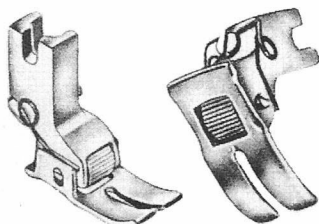

# R2

Large Wheel Roller and Specially Designed Spring allows for Better Feeding Action.

**AVAILABLE SEPARATELY: # R2-1 Spring**

**SLIDE RING TEFLON FEET**  
With Posi-Traction Nylon Ring



(Left Illustrated)

Complete With Instructions

# SR-DB-R Slide Ring Teflon Foot Single Ring, Right Side For Sewing Skirts, Slacks, Slide Fasteners, Etc.

# SR-DB-W Slide Ring Teflon Foot Double Ring For Regular Seaming

# SR-DB-L Slide Ring Teflon Foot Single Ring, Left Side For Sewing Zippers, Tapes, Etc.

- ★ NO SEAM PUCKERING
- ★ PREVENTS MATERIAL STRETCHING
- MOVES TOGETHER WITH FEED DOG AND FEEDS THE CLOTH WITH ACCURACY. • SPECIALLY DESIGNED POSI-TRACTION RING ROTATES AS MATERIAL PASSES UNDER FOOT. • ACTION ELIMINATES FRICTION. • FOR BEST RESULTS RUBBERIZED FEEDERS ARE RECOMMENDED.

**AVAILABLE SEPARATELY:**  
# SR-DB-H Slide Ring (Hoop) Only For Slide Ring Teflon Foot

**MOLDED TEFLON\* ANTI-FRICTION FEET**

- ★ EXTRA STRONG AND DURABLE SOLID MOLDED TEFLON BOTTOM ON COMPENSATING TYPE SHANK
- ★ FOR USE ON LAMINATED FOAM, RUBBER FABRICS, PLASTICS, SYNTHETICS, LEATHERETTE, PILE FABRICS, ETC.
- ★ ELIMINATES DRAG AND PUCKER
- ★ INCREASE PRODUCTION AND REDUCE COST

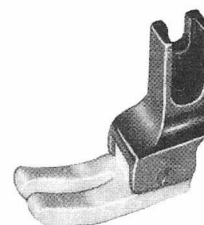

# MT1 For Singer Single Needle Drop Feed Lockstitch Machines

# UMT1 For Union Special Single Needle Lockstitch Classes: 61200, 61300, 61400 & 63400

**AVAILABLE SEPARATELY:**  
# MT2 Replaceable Bottom for # MT1 and # UMT1

**BLANK FOOT (WITH HOLE IN CENTER)**



# MT9 For Singer Single Needle Drop Feed Lockstitch Machines

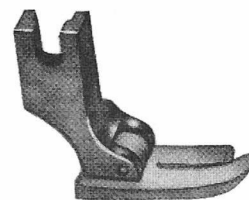

# MT20 (# 24983MT) (# 541585-002) For Singer Single Needle Drop Feed Lockstitch Machines

**AVAILABLE SEPARATELY:**  
# MT10 Replaceable Bottom

**AVAILABLE SEPARATELY:**  
# MT21 (# 24983MTB) Replaceable Bottom for # MT20

**ZIPPER FOOT**

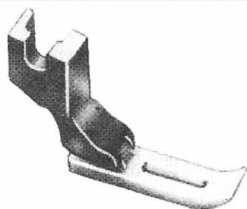

# **MT3** For Singer Single Needle Drop Feed Lockstitch Machines

# **UMT3** For Union Special Single Needle Lockstitch Classes: 61200, 61300, 61400 & 63400

**AVAILABLE SEPARATELY:**  
# **MT4** Replaceable Bottom for # **MT3** and # **UMT3**

**FOR NEEDLE FEED MACHINES**



# **MT5** For Singer Classes: 111W & 211W

**AVAILABLE SEPARATELY:**  
# **MT6** Replaceable Bottom

**FOR Class: 20U31**



# **MT23** (# 541566MT)

**AVAILABLE SEPARATELY:**  
# **MT24** Replaceable Bottom

**TEFLON COMPENSATING FOOT**

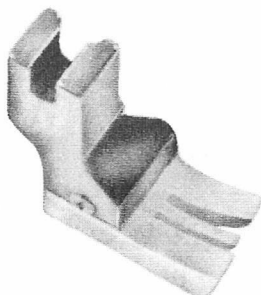

1/8" Left Illustrated  
**COMPLETE FEET LEFT**

- # **MT22** 1/32" Left
- # **MT221** 1/16" Left
- # **MT222** 1/8" Left
- # **MT223** 3/16" Left
- # **MT224** 1/4" Left

**RIGHT**

- # **MT21R** 1/32" Right
- # **MT211R** 1/16" Right
- # **MT212R** 1/8" Right
- # **MT213R** 3/16" Right
- # **MT214R** 1/4" Right

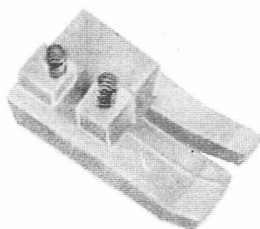

1/8" Left Illustrated  
**BOTTOM ONLY LEFT**

- # **MT22B** 1/32" Left
- # **MT221B** 1/16" Left
- # **MT222B** 1/8" Left
- # **MT223B** 3/16" Left
- # **MT224B** 1/4" Left

**RIGHT**

- # **MT21RB** 1/32" Right
- # **MT211RB** 1/16" Right
- # **MT212RB** 1/8" Right
- # **MT213RB** 3/16" Right
- # **MT214RB** 1/4" Right

**FOR PFAFF SINGLE NEEDLE LOCKSTITCH**



# **MT7**

**AVAILABLE SEPARATELY:**  
# **MT8** Replaceable Bottom

FOR BEST RESULTS, WE SUGGEST THE USE OF THESE FEET WITH TEFLON COATED PLATES & SPECIAL FEED DOGS WHICH ARE EITHER TEFLON COATED, DIAMOND CUT OR RUBBERIZED.