

RIGHT ANGLE BINDER SETS

BINDING STAND SUPPLIED WITH EACH BINDER SET

★ QUICK ADJUSTMENT FEATURE ★ ADJUSTABLE FOR ALL SHAPES OF GARMENTS ★ INDIVIDUALLY BOXED

C.G. For Dresses, Sportswear, etc.
O.C. For Overcoats, Suitings and Topcoats

FINISHES:

3/4" Cut Size = 3/16" Finished Size	1 1/8" Cut Size = 5/16" Finished Size	1 1/2" Cut Size = 7/16" Finished Size
7/8" Cut Size = 7/32" Finished Size	1 1/4" Cut Size = 3/8" Finished Size	1 3/4" Cut Size = 9/16" Finished Size
1" Cut Size = 1/4" Finished Size	1 3/8" Cut Size = 13/32" Finished Size	2" Cut Size = 1 1/16" Finished Size

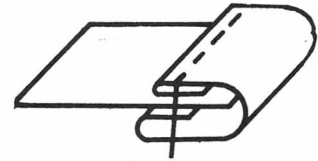

CLEAN FINISH TOP AND BOTTOM

Approximate Finish only. Finished size may vary with type of material and bias cut.

COMPLETE RIGHT ANGLE BINDER SET CONSISTS OF
BINDER FOOT (Regular or Compensating); BINDER FEEDER; BINDER HEAD AND PLATE

FOR SINGER

SINGLE NEEDLE DROP FEED LOCKSTITCH MACHINES (Classes: 31, 44, 95, 96, 191D, 195K, 196K, 241, 245, 251, 281, 331K, 366K, 400W, 451K, 491, 591D, 600W, 660A, 770, 771, 1300 and CENTURION 121D)

RIGHT ANGLE BINDER SETS WITH REGULAR BINDER FOOT

- | | |
|---|---|
| #S60 3/4CG (#490341 3/4)
Set C.G. 3/4" | #S60 13/4CG (#490341 13/4)
Set C.G. 1 3/4" |
| #S60 7/8CG (#490341 7/8)
Set C.G. 7/8" | #S60 2 CG (#490341 2)
Set C.G. 2" |
| #S60 1CG (#490341 1) Set
C.G. 1" | #S60 3/4OC Set O.C. 3/4" |
| #S60 11/8CG (#490341 11/8)
Set C.G. 1 1/8" | #S60 7/8OC Set O.C. 7/8" |
| #S60 11/4CG (#490341 11/4)
Set C.G. 1 1/4" | #S60 1OC Set O.C. 1" |
| #S60 13/8CG (#490341 13/8)
Set C.G. 1 3/8" | #S60 11/8OC Set O.C. 1 1/8" |
| #S60 11/2CG (#490341 11/2)
Set C.G. 1 1/2" | #S60 11/4OC Set O.C. 1 1/4" |
| #S60 15/8CG (#490341 15/8)
Set C.G. 1 5/8" | #S60 13/8OC Set O.C. 1 3/8" |
| | #S60 11/2OC Set O.C. 1 1/2" |
| | #S60 15/8OC Set O.C. 1 5/8" |
| | #S60 13/4OC Set O.C. 1 3/4" |
| | #S60 2OC Set O.C. 2" |

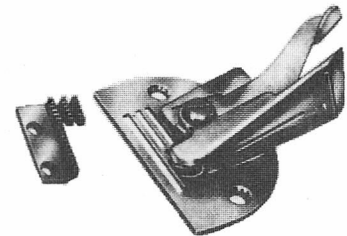

BINDER FEEDER

- #770B Binder Feeder (Used up to 1")
- #20002 Binder Feeder (Over 1")



REGULAR BINDER FOOT
#12142C

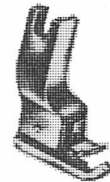

COMPENSATING BINDER FOOT
#601 For 3/4" or 7/8" Binding
#602 For 1" or 1 1/8" Binding
#604 For 1 1/4" or Wider Binding

RIGHT ANGLE BINDER SETS WITH COMPENSATING BINDER FOOT

- | | |
|-------------------------|-------------------------|
| #S60 3/4W/C Set 3/4" | #S60 13/8W/C Set 1 3/8" |
| #S60 7/8W/C Set 7/8" | #S60 11/2W/C Set 1 1/2" |
| #S60 1W/C Set 1" | #S60 15/8W/C Set 1 5/8" |
| #S60 11/8W/C Set 1 1/8" | #S60 13/4W/C Set 1 3/4" |
| #S60 11/4W/C Set 1 1/4" | #S60 2W/C Set 2" |

FOR UNION SPECIAL

SINGLE NEEDLE LOCKSTITCH Classes: 61200, 61300, 61400 & 63400

RIGHT ANGLE BINDER SETS WITH REGULAR BINDER FOOT

- | | |
|-----------------------|-----------------------|
| #SU60 3/4 Set 3/4" | #SU60 11/4 Set 1 1/4" |
| #SU60 7/8 Set 7/8" | #SU60 13/8 Set 1 3/8" |
| #SU60 1 Set 1" | #SU60 11/2 Set 1 1/2" |
| #SU60 11/8 Set 1 1/8" | |

RIGHT ANGLE BINDER SETS WITH COMPENSATING BINDER FOOT

- | | |
|-----------------------|--------------------------|
| #SU60 3/4W/C Set 3/4" | #SU60 11/4W/C Set 1 1/4" |
| #SU60 7/8W/C Set 7/8" | #SU60 13/8W/C Set 1 3/8" |
| #SU60 1W/C Set 1" | #SU60 11/2W/C Set 1 1/2" |



REGULAR BINDER FOOT
#61220H

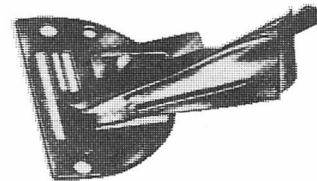

BINDER FEEDER
#61405L



COMPENSATING BINDER FOOT
#601US For 3/4" or 7/8" Binding
#602US For 1" or 1 1/8" Binding
#604US For 1 1/4" or Wider Binding

SEPARATE PARTS AVAILABLE FOR ALL BINDER SETS:

- | | |
|-----------------------|---------------------------|
| #S60-7 Binder Washer | #S60-9 Binder Lever |
| #S60-8 Binder Bracket | #BLS10 Binder Lever Screw |

ADJUSTABLE RIGHT ANGLE BINDER SETS

FOR SINGER, UNION SPECIAL JUKI, BROTHER & MITSUBISHI SINGLE NEEDLE LOCKSTITCH MACHINES

- AVAILABLE IN 3 MOST POPULAR SIZES
- RAW EDGES DISAPPEAR
- TOP & BOTTOM EDGES ALWAYS EVEN

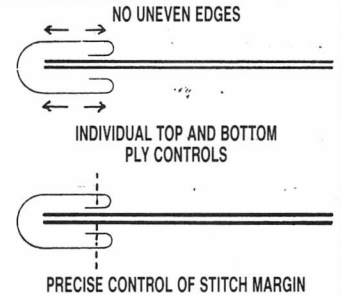
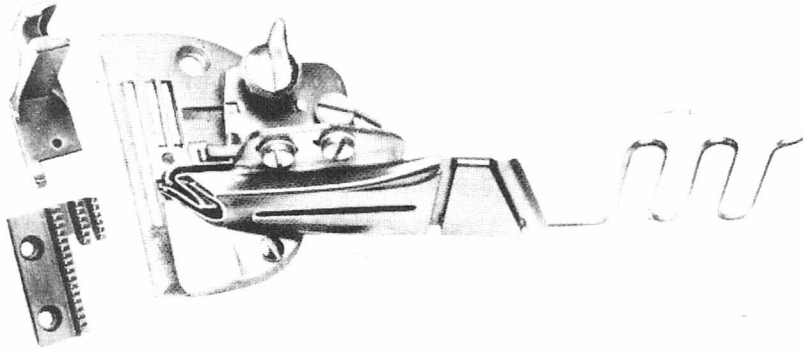

- #S60A1 Set with Foot & Feed Dog 1" (26 MM)
- #S60A1 1/4 Set with Foot & Feed Dog 1 1/4" (32 MM)
- #S60A1 1/2 Set with Foot & Feed Dog 1 1/2" (40 MM)

- AVAILABLE SEPARATELY:**
- #S60AP-01 Plate For #S60A1 (26 MM)
 - #S60AP-03 Plate For #S60A 1 1/4 (32 MM) & #S60A 1 1/2 (40 MM)
 - #S60AF-1 Foot For #S60A1 (26 MM)
 - #S60AF-1 1/4 Foot For #S60A1 1/4 (32 MM)
 - #S60AF-1 1/2 Foot For #S60A1 1/2 (40 MM)
 - #S60AF Feeder For All Sizes

THE WORLD'S
FINEST

HEMMERS AND BINDERS

INDIVIDUALLY
BOXED

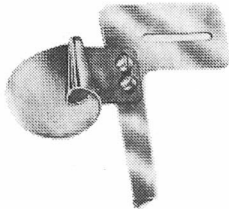

PLAIN SAFETY HEMMER

- # 400 1/16 1/16"
- # 400 1/8 1/8"
- # 400 3/16 3/16"
- # 400 1/4 1/4"
- # 405 3/8 3/8"
- # 405 1/2 1/2"

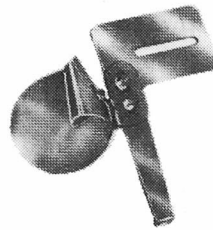

SPRING SAFETY HEMMER

- # 450 1/16 1/16"
- # 450 1/8 1/8"
- # 450 3/16 3/16"
- # 450 1/4 1/4"

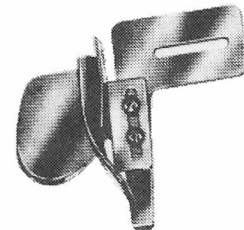

PLAIN BRAID OR TAPE BINDER

- # 1003/8 3/8" Raw Edge
- # 1001/2 1/2"
- # 1005/8 5/8"
- # 1003/4 3/4"
- # 100LS7/8 7/8"
- # 100LS1 1"

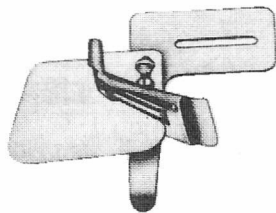

DOUBLE FOLD PLAIN BINDER

- # 508 5/8 5/8"
- # 508 3/4 3/4"
- # 508 7/8 7/8"
- # 508 1 1"

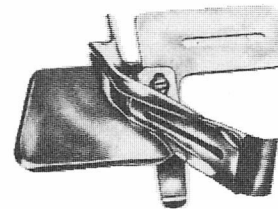

DOUBLE FOLD PLAIN BINDER

- # 508LS11/8 1 1/8"
- # 508LS11/4 1 1/4"
- # 508LS11/2 1 1/2"
- # 508LS13/4 1 3/4"
- # 508LS2 2"

- PARTS AVAILABLE SEPARATELY:**
- # 400-31 Handle (Hook Gauge)
 - # 400-32 Hemmer Bracket
 - # 1443 1/8 Hemmer Screw 1/8"
 - # 1443 3/16 Hemmer Screw 3/16"
 - # 1443 1/4 Hemmer Screw 1/4"
 - # 1443 3/8 Hemmer Screw 3/8"
 - # 450S 1/16 Hemmer Spring 1/16"
 - # 450S 1/8 Hemmer Spring 1/8"
 - # 450S 3/16 Hemmer Spring 3/16"
 - # 450S 1/4 Hemmer Screw 1/4"

THE WORLD'S
FINEST

HEMMERS AND BINDERS

INDIVIDUALLY
BOXED

FOR SINGER

SINGLE NEEDLE DROP FEED LOCKSTITCH MACHINES (Classes: 31, 44, 95, 96, 191D, 195K, 196K, 241, 245, 251, 281, 331K, 366K, 400W, 451K, 491, 591D, 600W, 660A, 770, 771, 1300 and CENTURION 121D)

BINDING STAND SUPPLIED WITH EACH BINDER SET

SEMI-FOLD BINDER

(Clean Finish Top, Raw Edge Underside)



SEMI-FOLD
BINDING FOOT
S62F
(All Sizes)

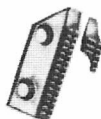

FEED DOG
44136
(# 149136)

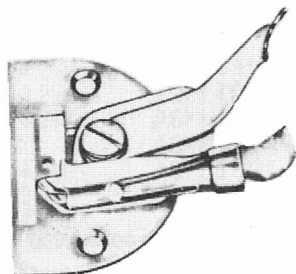

S62 1/2 1/2"
S62 5/8 5/8"
S62 3/4 3/4"
S62 7/8 7/8"
S62 1 1"

SETS:

S62 11/8 1 1/8"
S62 11/4 1 1/4"
S62 13/8 1 3/8"
S62 11/2 1 1/2"

RAW EDGE BINDER

(BRAID or TAPE)



RAW-EDGE BINDING FOOT

S64F1/2 1/2"
S64F5/8 5/8"
S64F3/4 3/4"
S64F7/8 7/8"
S64F1 1"
S64F11/8 1 1/8"
S64F11/4 1 1/4"

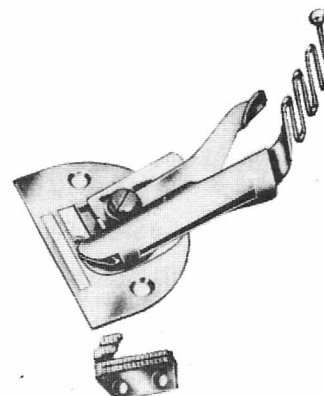

FEED DOG
44136 (# 149136)

SETS:

S64 1/2 (# 490385 1/2) 1/2"
S64 5/8 (# 490385 5/8) 5/8"
S64 3/4 (# 490385 3/4) 3/4"
S64 7/8 (# 490385 7/8) 7/8"
S64 1 (# 490385 1) 1"
S64 11/8 (# 490385 11/8) 1 1/8"
S64 11/4 (# 490385 11/4) 1 1/4"

82

COLLARETTE BINDER

FOR UNION SPECIAL Classes: 52700, 52800, 57700 & 57800; YAMATO Classes: DV-203 & 1203 and DW-303 & 1303;
PEGASUS Classes: W-61 and KANSAI SPECIAL Classes: DVK-1701F, DWK-1802K, ETC.

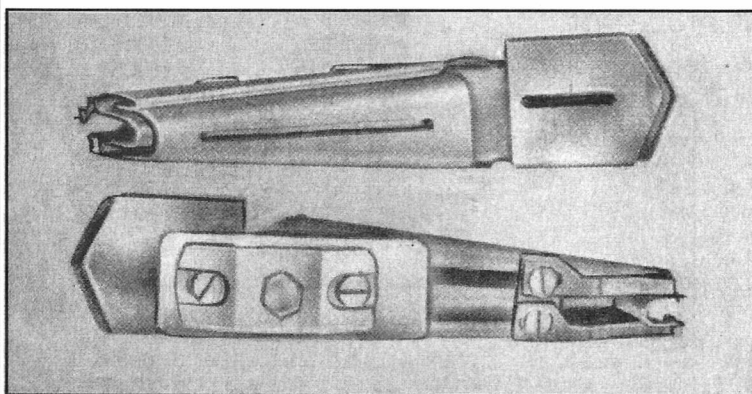

CLEAN FINISH TOP, RAW EDGE BOTTOM

INDIVIDUALLY PACKED

S12311/8 1 1/8" Tape Size (28MM) Finish: 3/8"—10MM)
S12311/4 1 1/4" Tape Size (32MM) Finish: 1/2"—12MM)
S12311/2 1 1/2" (1 9/16") Tape Size (40MM) Finish: 5/8"—15MM)
S1232 2" Tape Size (50MM) Finish: 3/4"—20MM)

For Plates, Feeders and Feet . . . Refer to Individual Listings

STAINLESS STEEL SWING HEMMER

FOR BLINDSTITCH MACHINES

★ Used for hemming all kinds of wearing apparel, curtains and draperies. Operator can swing hemmer away from the foot for finishing the bottom hem of a closed garment.

HEMMERS, COMPLETE:

- | | | |
|----------------|--------------------|--------------------|
| #S72B 1/4 1/4" | #S72B 1 1" | #S72B 2 1/2 2 1/2" |
| #S72B 3/8 3/8" | #S72B 1 1/4 1 1/4" | #S72B 3 3" |
| #S72B 1/2 1/2" | #S72B 1 1/2 1 1/2" | #S72B 3 1/2 3 1/2" |
| #S72B 5/8 5/8" | #S72B 1 3/4 1 3/4" | #S72B 4 4" |
| #S72B 3/4 3/4" | #S72B 2 2" | #S72B 5 5" |
| | | #S72B 6 6" |

SPECIAL FEATURE:
Adjustable to and from the Needle Point

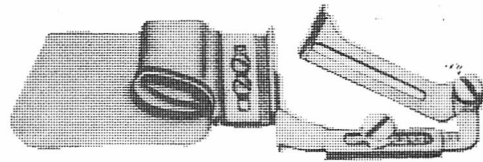

CLEAN FINISH

STAINLESS STEEL SWING HEMMER

FOR SINGLE NEEDLE LOCKSTITCH MACHINES

★ Used for hemming all kinds of apparel, also curtains and draperies. Operator can swing hemmer away from the foot for finishing the bottom of a closed garment.

NOTE: All 2" and over LOCKSTITCH HEMMERS Have Special Adjustable Feature. Adjustable to and from the Needle Point.



CLEAN FINISH

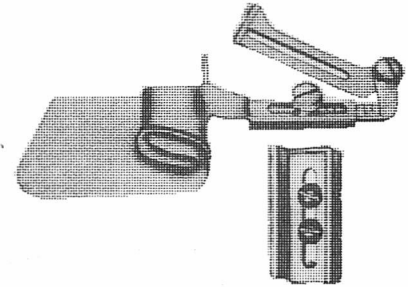

HEMMERS, COMPLETE:

- | | | | | |
|------------------------------|------------------------------------|------------------------------------|----------------------------------|------------------------------------|
| #S72L 1/4 (#490344 1/4) 1/4" | #S72L 3/4 (#490344 3/4) 3/4" | #S72L 1 1/4 (#490344 1 1/4) 1 1/4" | #S72L 13/4 (#490344 13/4) 1 3/4" | #S72L 3 1/2 (#490344 3 1/2) 3 1/2" |
| #S72L 3/8 (#490344 3/8) 3/8" | #S72L 1 (#490344 1) 1" | #S72L 1 1/2 (#490344 1 1/2) 1 1/2" | #S72L 2 (#490344 2) 2" | #S72L 4 (#490344 4) 4" |
| #S72L 1/2 (#490344 1/2) 1/2" | #S72L 1 1/4 (#490344 1 1/4) 1 1/4" | #S72L 2 1/2 (#490344 2 1/2) 2 1/2" | #S72L 3 (#490344 3) 3" | #S72L 5 (#490344 5) 5" |
| #S72L 5/8 (#490344 5/8) 5/8" | #S72L 1 1/2 (#490344 1 1/2) 1 1/2" | #S72L 3 (#490344 3) 3" | | #S72L 6 (#490344 6) 6" |

PARTS AVAILABLE SEPARATELY:
#S72-9 Hemmer Bracket Set

STAINLESS STEEL MOUSE TRAP LATCH BLINDSTITCH HEMMERS

ALL BLINDSTITCH LATCH HEMMERS ARE ADAPTABLE FOR LOCKSTITCH MACHINES

★ Used for finishing bottom hems on dresses, skirts, and other circular garments.

HEMMERS, COMPLETE:

- | | |
|-------------------|-------------------|
| #S73 1 1" | #S73 2 1/2 2 1/2" |
| #S73 1 1/4 1 1/4" | #S73 3 3" |
| #S73 1 1/2 1 1/2" | #S73 4 4" |
| #S73 2 2" | |



CLEAN FINISH

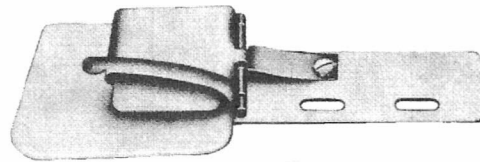

PARTS AVAILABLE SEPARATELY:
#S73SP Hemmer Spring

ADJUSTABLE STAINLESS STEEL MOUSE TRAP LATCH BLINDSTITCH HEMMERS

ALL BLINDSTITCH LATCH HEMMERS ARE ADAPTABLE FOR LOCKSTITCH MACHINES

★ Used for finishing bottom hems on dresses, skirts, and other circular garments.

★ SET COMES WITH ANY 5 SHELLS



CLEAN FINISH

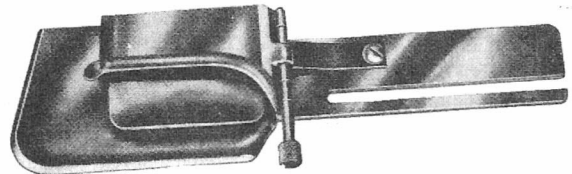

WHEN CHANGING SHELLS
JUST REMOVE PIN

HEMMER COMPLETE WITH 5 SHELLS

#S74A (#490346)

★ SPECIFY SIZE OF SHELLS WHEN ORDERING

- PARTS AVAILABLE SEPARATELY:
- | | |
|---------------------------------------|---------------------------------------|
| #S74A 1/2 Latch Hemmer Shell 1/2" | #S74A 2 1/2 Latch Hemmer Shell 2 1/2" |
| #S74A 3/4 Latch Hemmer Shell 3/4" | |
| #S74A 1 Latch Hemmer Shell 1" | #S74A 3 Latch Hemmer Shell 3" |
| #S74A 1 1/4 Latch Hemmer Shell 1 1/4" | #S73SP Hemmer Spring |
| #S74A 1 1/2 Latch Hemmer Shell 1 1/2" | #S74AP Pin |
| #S74A 2 Latch Hemmer Shell 2" | |

SUPERIOR ADJUSTABLE SPLIT HEMMER FOR ALL BLINDSTITCH MACHINES

EXCLUSIVE CUT-OUT TO FIT ALL BLINDSTITCH MACHINES

This ADJUSTABLE SPLIT HEMMER is designed and constructed, so that it proves to be the best attachment for making hems of all sizes on dresses, skirts, underwear, etc. both light and heavy materials work equally well with this hemmer.



CLEAN FINISH

Complete with any 3 size shells
NOW 19 SHELLS TO CHOOSE FROM

SHELLS AVAILABLE SEPARATELY:

- | | | |
|-------------------|-------------------|-------------------|
| #S71 1/2 1/2" | #S71 21/4 2 1/4" | #S71 4 4" |
| #S71 3/4 3/4" | #S71 21/2 2 1/2" | #S71 4 1/4 4 1/4" |
| #S71 1 1" | #S71 23/4 2 3/4" | #S71 4 1/2 4 1/2" |
| #S71 1 1/4 1 1/4" | #S71 3 3" | #S71 4 3/4 4 3/4" |
| #S71 1 1/2 1 1/2" | #S71 3 1/4 3 1/4" | #S71 5 5" |
| #S71 1 3/4 1 3/4" | #S71 3 1/2 3 1/2" | |
| #S71 2 2" | #S71 3 3/4 3 3/4" | |

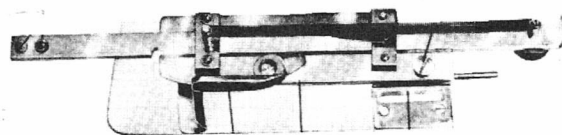

ADJUSTABLE SPLIT HEMMER FOR BLINDSTITCH MACHINES COMPLETE WITH 3 SHELLS
#S71

To operate the ADJUSTABLE SPLIT HEMMER, place the desired size shell on the shell bar and screw down (1). Loosen screw (2) which then permits the adjustable arm (3) to be moved freely, so that it can act as the back wall of the hemmer for the hemmer shell used. Then, tighten screw (2). The lever (4) opens the hemmer for finishing. There is an adjustable check spring (5) which permits the hemmer to open without knocking. Hemmer can be regulated to open slower or faster. The slot (6) is where hemmer is fastened to machine.

OTHER PARTS AVAILABLE SEPARATELY:

- | | |
|--|--|
| #ASH 100 Adjustable Split Hemmer Slide Bar | #ASH 106 Adjustable Split Hemmer Slide Bar Spring Stud |
| #ASH 101 Adjustable Split Hemmer Slide Bar Bumper | #ASH 107 Adjustable Split Hemmer Trip Lever |
| #ASH 102 Adjustable Split Hemmer Shell Screw | #ASH 108 Adjustable Split Hemmer Trip Lever Screw |
| #ASH 103 Adjustable Split Hemmer Slide Bar Flat Spring | #ASH 109 Adjustable Split Hemmer Trip Lever Spring |
| #ASH 104 Adjustable Split Hemmer Slide Bar Flat Spring Screw | #ASH 110 Adjustable Split Hemmer Guide & Bar |
| #ASH 105 Adjustable Split Hemmer Slide Hemmer Slide Bar Spring | #ASH 111 Adjustable Split Hemmer Guide & Bar Screw |
| | #ASH 112 Adjustable Split Hemmer Slide Block Screw |

84

STAINLESS STEEL SPLIT HEMMER



STAINLESS STEEL SPLIT HEMMER FOR BLINDSTITCH MACHINE ILLUSTRATED

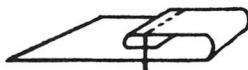

CLEAN FINISH

- For Use On Dresses, Shorts and similar articles.
- Closed Garments can be finished by swinging out the inner portion of the hemmer.

STAINLESS STEEL SPLIT HEMMERS FOR SINGLE NEEDLE LOCKSTITCH MACHINES

- #S81 1 (# 490345 1) Lockstitch Split Hemmer 1"
- #S81 1 1/2 (# 490345 1 1/2) Lockstitch Split Hemmer 1 1/2"
- #S81 2 (# 490345 2) Lockstitch Split Hemmer 2"
- #S81 2 1/2 (# 490345 2 1/2) Lockstitch Split Hemmer 2 1/2"
- #S81 3 (# 490345 3) Lockstitch Split Hemmer 3"

STAINLESS STEEL SPLIT HEMMERS FOR BLINDSTITCH MACHINES

- #S81B 1 Blindstitch Split Hemmer 1"
- #S81B 1 1/2 Blindstitch Split Hemmer 1 1/2"
- #S81B 2 Blindstitch Split Hemmer 2"
- #S81B 2 1/2 Blindstitch Split Hemmer 2 1/2"
- #S81B 3 Blindstitch Split Hemmer 3"

PARTS AVAILABLE SEPARATELY:

- | | |
|--------------------------------|-------------------------------------|
| #S81C 1 Coil Spring 1" | #S81ST 1 Straight Spring 1" |
| #S81C 1 1/2 Coil Spring 1 1/2" | #S81ST 1 1/2 Straight Spring 1 1/2" |
| #S81C 2 Coil Spring 2" | #S81ST 2 Straight Spring 2" |
| #S81C 2 1/2 Coil Spring 2 1/2" | #S81ST 2 1/2 Straight Spring 2 1/2" |
| #S81C 3 Coil Spring 3" | #S81ST 3 Straight Spring 3" |

SINGLE TURN HEMMERS

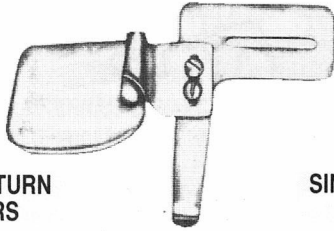

SINGLE UPTURN HEMMERS

- #S75U 3/16 3/16"
- #S75U 1/4 1/4"
- #S75U 3/8 3/8"
- #S75U 1/2 1/2"

SINGLE DOWNTURN HEMMERS

- #S75D 3/16 3/16"
- #S75D 1/4 1/4"
- #S75D 3/8 3/8"
- #S75D 1/2 1/2"

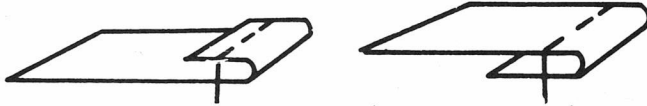

SINGLE TURN HEMMERS WITH SWING-AWAY BRACKET

★ FOR LOCKSTITCH & BLINDSTITCH MACHINES

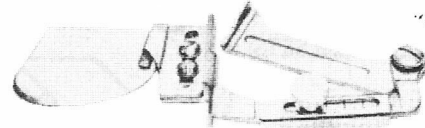

SINGLE TURN HEMMERS WITH SWING-AWAY BRACKET

- #SW75U 3/16 Upturn With Swing-Away Bracket 3/16"
- #SW75U 1/4 Upturn With Swing-Away Bracket 1/4"
- #SW75U 3/8 Upturn With Swing-Away Bracket 3/8"
- #SW75U 1/2 Upturn With Swing-Away Bracket 1/2"
- #SW75D 3/16 Downturn With Swing-Away Bracket 3/16"
- #SW75D 1/4 Downturn With Swing-Away Bracket 1/4"
- #SW75D 3/8 Downturn With Swing-Away Bracket 3/8"
- #SW75D 1/2 Downturn With Swing-Away Bracket 1/2"

3 WAY BLINDSTITCH DRAPERY HEMMERS

★ USED ON DRAPERIES, SHIRTS, ETC.
★ FULL TURN HEMMER, CLEAN FINISH



- #S92B1/2 1/2"
- #S92B3/4 3/4"
- #S92B1 1"
- #S92B11/4 1 1/4"
- #S92B11/2 1 1/2"
- #S92B13/4 1 3/4"
- #S92B2 2"
- #S92B3 3"
- #S92B4 4"

3 WAY LOCKSTITCH DRAPERY HEMMERS

- #S92L1/2 1/2"
- #S92L3/4 3/4"
- #S92L1 1"
- #S92L11/4 1 1/4"
- #S92L11/2 1 1/2"
- #S92L13/4 1 3/4"
- #S92L2 2"
- #S92L3 3"
- #S92L4 4"

LATCH HEMMERS

★ Simple Press On Lever
Snaps Up Top Of Hem
Making It Possible To
Finish Hems On Shorts,
Sleeves, Pajama Legs, etc.



CLEAN FINISH

★ For Hemming Circular Garments

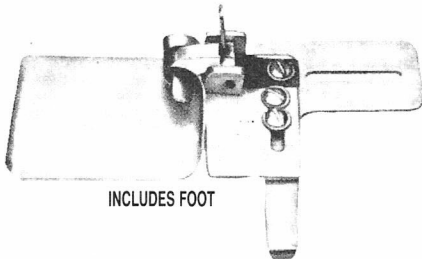

INCLUDES FOOT

LATCH HEMMERS FOR SINGLE NEEDLE LOCKSTITCH MACHINES:

- #S78 1/4 for Lockstitch 1/4"
- #S78 3/8 for Lockstitch 3/8"
- #S78 1/2 for Lockstitch 1/2"
- #S78 5/8 for Lockstitch 5/8"
- #S78 3/4 for Lockstitch 3/4"
- #S78 1 for Lockstitch 1"

LATCH HEMMERS FOR BLINDSTITCH MACHINES:

- #S78B 1/4 for Blindstitch 1/4"
- #S78B 3/8 for Blindstitch 3/8"
- #S78B 1/2 for Blindstitch 1/2"
- #S78B 5/8 for Blindstitch 5/8"
- #S78B 3/4 for Blindstitch 3/4"
- #S78B 1 for Blindstitch 1"

SHIRT TAIL SPRING HEMMER SETS FOR SINGER SINGLE NEEDLE LOCKSTITCH

★ COMPLETE WITH FEEDER AND FOOT

Cross seams can pass through this hemmer with ease due to a special spring.

Made with foot, feed dog and swing-away bracket for easy finishing.

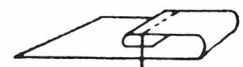

CLEAN FINISH

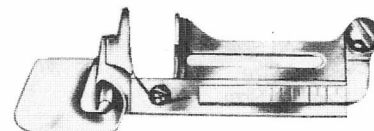

SHIRT TAIL SPRING HEMMER SETS:

- #S70 1/4 Set 1/4"
- #S70 3/8 Set 3/8"
- #S70 1/2 1/2"
- #S70 1/16 Set 1/16"
- #S70 1/8 Set 1/8"
- #S70 3/16 3/16"

FEED DOG AVAILABLE SEPARATELY:



#S70FE

FEET AVAILABLE SEPARATELY:



- #S70F1/16 1/16"
- #S70F1/8 1/8"
- #S70F3/16 3/16"
- #S70F1/4 1/4"
- #S70F3/8 3/8"
- #S70F1/2 1/2"

TONGUE HEMMERS

- ★ For hemming short strips such as used on pocket tops or pajamas, shirts, jeans, etc.
- ★ Material is easily fitted into hemmer and machine

TONGUE HEMMER SETS:

- #S76 3/4 3/4"
- #S76 1 1"
- #S76 1 1/4 1 1/4"
- #S76 1 1/2 1 1/2"
- #S76 2 2"

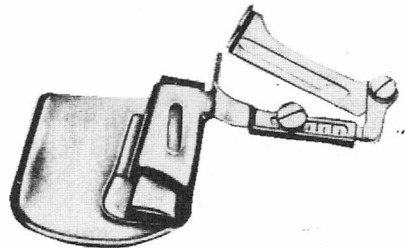

LONG CORE HEMMERS

- ★ Used for curtains, shirt fronts, sheets, pillow cases, etc.
- ★ The long core provides full control at high speeds for continuous long run hemming

LONG CORE HEMMER SETS:

- #S77 3/4 3/4"
- #S77 1 1"
- #S77 1 1/4 1 1/4"
- #S77 1 1/2 1 1/2"
- #S77 2 2"

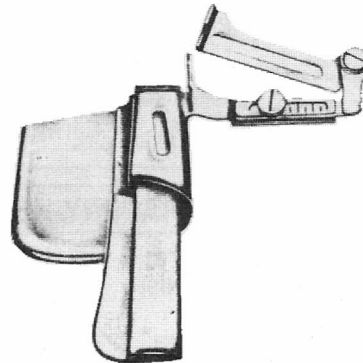

PLACKET FOLDERS

- ★ For sewing sleeve facings and plackets on to garments in one operation
- ★ Made especially for short lengths of binding which can quickly be inserted in this type folder

PLACKET FOLDERS:

- #S50 1 1/4 (# 490397 1 1/4) 1 1/4"
- #S50 1 1/2 (# 490397 1 1/2) 1 1/2"
- #S50 1 3/4 (# 490397 1 3/4) 1 3/4"
- #S50 2 (# 490397 2) 2"
- #S50 2 1/4 (# 490397 2 1/4) 2 1/4"
- #S50 2 1/2 (# 490397 2 1/2) 2 1/2"
- #S50 3 (# 490397 3) 3"
- #S50 3 1/4 (# 490397 3 1/4) 3 1/4"
- #S50 3 1/2 (# 490397 3 1/2) 3 1/2"

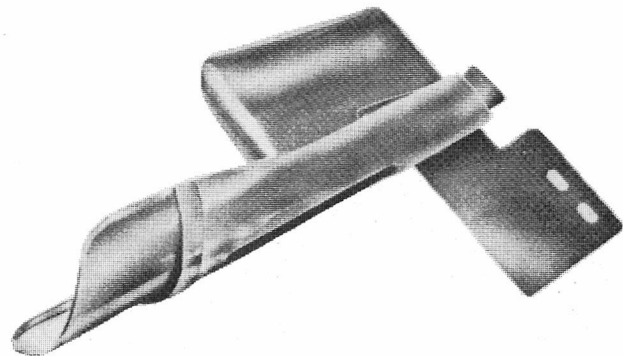

INCLUDES #S542 HEMMING FOOT

FINISHES:

- | | |
|-------------------------------------|---------------------------------------|
| 1/4" Cut Size= 3/8" Finished Size | 2 1/2" Cut Size= 1" Finished Size |
| 1 1/2" Cut Size= 1/2" Finished Size | 3" Cut Size= 1 1/8" Finished Size |
| 1 3/4" Cut Size= 5/8" Finished Size | 3 1/4" Cut Size= 1 1/4" Finished Size |
| 2" Cut Size= 3/4" Finished Size | 3 1/2" Cut Size= 1 1/2" Finished Size |
| 2 1/4" Cut Size= 7/8" Finished Size | |

BELT LOOP FOLDERS

- ★ FOR UNION SPECIAL Classes: 52700, 69000, Etc. Covering Stitch Machines

Used for producing Belt Loops on Double Needle Machines from short strips of materials.

BELT LOOP FOLDER, COMPLETE:

- #S66 3/4 3/4"
- #S66 7/8 7/8"
- #S66 1 1"
- #S66 1 1/8 1 1/8"
- #S66 1 1/4 1 1/4"
- #S66 1 1/2 1 1/2"

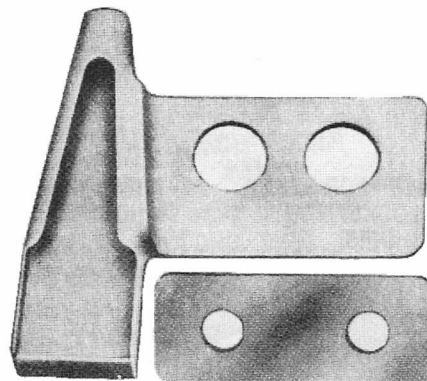
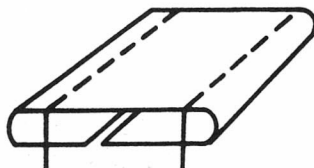

- PARTS AVAILABLE SEPARATELY:**
- #23425V Belt Loop Folder Bracket
 - #25C Screw



CORD EDGE PIPING ATTACHMENTS

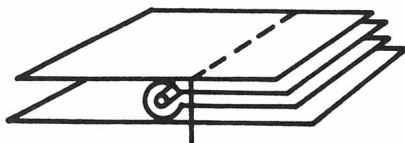

**CORE EDGE PIPING ATTACHMENTS
FOR SINGER SINGLE NEEDLE LOCKSTITCH:**

- #S65 5/8 (# 490350 5/8) 5/8"
- #S65 3/4 (# 490350 3/4) 3/4"
- #S65 7/8 (# 490350 7/8) 7/8"
- #S65 1 (# 490350 1) 1"

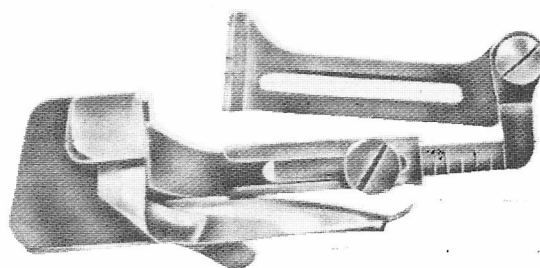

**CORE EDGE PIPING ATTACHMENTS
FOR UNION SPECIAL SINGLE NEEDLE LOCKSTITCH:**

- #SU65 5/8 5/8"
- #SU65 3/4 3/4"
- #SU65 7/8 7/8"
- #SU65 1 1"

SPAGHETTI ATTACHMENTS

NEW STYLE, IMPROVED, PLATE MOUNTED UNIT...FOR EASIER USE!

- For Producing a Spaghetti-Like Tubing or Piping from Open Binding.
- Binding is Turned Inside Out, leaving Stitches Hidden.
- Finished Product is Ideal for Making Trimmings, Loops, etc.

SPAGHETTI ATTACHMENTS, COMPLETE

- #S53 5/8 (# 490354 5/8) 5/8"
- #S53 3/4 (# 490354 3/4) 3/4"
- #S53 7/8 (# 490354 7/8) 7/8"
- #S53 1 (# 490354 1) 1"
- #S53 1 1/8 (# 490354 1 1/8) 1 1/8"
- #S53 1 1/4 (# 490354 1 1/4) 1 1/4"
- #S53 1 1/2 (# 490354 1 1/2) 1 1/2"

FINISHES:

- 5/8" Cut Size = 5/32" Finished Size
- 3/4" Cut Size = 3/16" Finished Size
- 7/8" Cut Size = 7/32" Finished Size
- 1" Cut Size = 1/4" Finished Size

- 1 1/8" Cut Size = 5/16" Finished Size
- 1 1/4" Cut Size = 3/8" Finished Size
- 1 1/2" Cut Size = 7/16" Finished Size

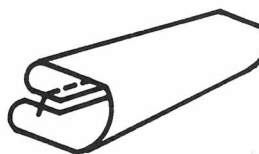
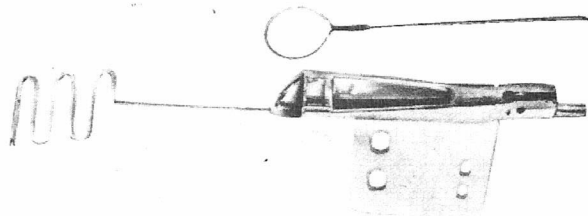

**1/4" TOP STITCH JOINER AND FOOT
(YOKE ATTACHMENT)**



1/4" TOP STITCH JOINER & FOOT SETS:

- #S51L Left Feed
- #S51R Right Feed (Reverse)

This Attachment makes a Single Downturn Hem joined to another piece of material forming a Top Stitch Seam.
ADJUSTABLE AT ALL POINTS FOR DEPTH STITCHING.

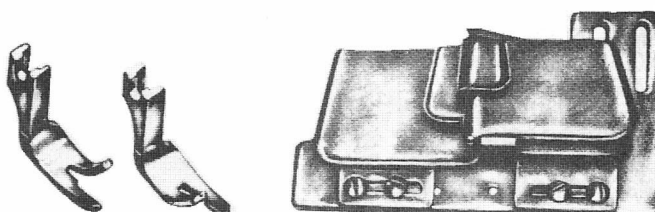

Right Foot Left Foot

**SWING OUT BRASSIERE
AND CORSET ATTACHMENT**

RECOMMENDED WITH USE OF
BRASSIERE FOOT WITH COMPENSATING GUIDE

Used on Singer Class: 112W, 212W and 212G Machines for Joining operations.

Covered stripper gives a smooth surface for corner making and flat work.

Top folder can be swung out, for making of corners, by moving the finger release.

Lock spring catch prevents swing arm from vibrating out of position.

Curved top folder platform keeps seams from catching.

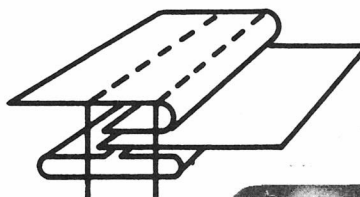

STAINLESS STEEL

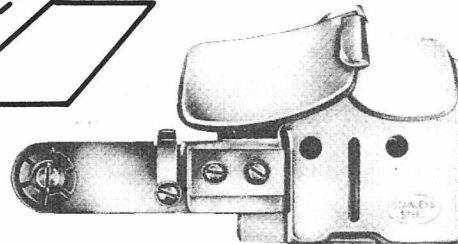

**SWING OUT BRASSIERE & CORSET
ATTACHMENTS, COMPLETE:**

- #S110 3/16 (# 490353 3/16) 3/16"
- #S110 1/4 (# 490353 1/4) 1/4"

**BRASSIERE FOOT
WITH COMPENSATING GUIDE**

★ GIVES EVEN MARGINS AT ALL TIMES

- #S570 1/8 Gauge Size: 1/8"
- #S570 3/16 Gauge Size: 3/16"
- #S570 1/4 Gauge Size: 1/4"
- #S570 5/16 Gauge Size: 5/16"
- #S570 3/8 Gauge Size: 3/8"
- #S570 7/16 Gauge Size: 7/16"
- #S570 1/2 Gauge Size: 1/2"
- #S570 9/16 Gauge Size: 9/16"



ADJUSTABLE RIC RAC OR LACE GUIDE

- ★ Adjustable to 3/8"
- ★ Used with either a raw edge or clean finish hemmer.
- ★ For any plain Singer machine.

PARTS AVAILABLE SEPARATELY:

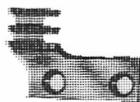

FEED DOG
#S79F

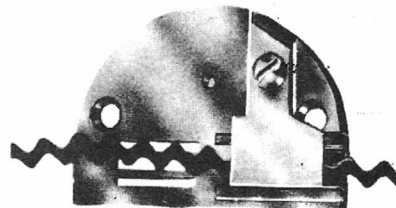

ADJUSTABLE RIC RAC OR LACE GUIDE,
COMPLETE
#S79

ADJUSTABLE GUIDE TUBE

- ★ Used To Sew Lace, Ribbon, Ric-Rac, Braid or Trimming From 1/8" to 1 3/4" Widths Evenly From Center to Either Edge On to Garment.

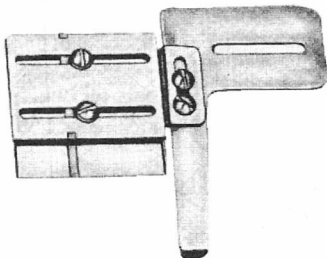

ADJUSTABLE GUIDE TUBE
#S52

STITCHED ELASTIC SWING HEMMER

FOR SINGLE NEEDLE MACHINES

- ★ This is a Turn-Up Hemmer that stitches Elastic end to end while sewing.
- ★ This eliminates tacking at both ends.
- ★ Available in Standard 1/4" Size Only.
- ★ Amount of Gathering is Obtained by Adjusting Special Tension Bracket.

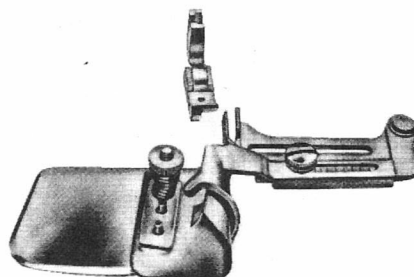

STITCHED ELASTIC SWING HEMMER
#S91 1/4

KISSABLE ZIPPER ATTACHMENT

FOR USE ON ALL METAL, NYLON—SEPARATOR ZIPPERS
FOR SINGLE NEEDLE LOCKSTITCH MACHINES

- ★ SAVES TIME
- ★ SNAG PROOF
- ★ NO PUCKERING
- ★ EASY TO USE
- ★ GOOD ON ALL FABRICS
- ★ ASSURES ACCURACY
- ★ COMPLETE EASY TO FOLLOW INSTRUCTIONS WITH EACH SET

COMPLETE SET CONSISTS OF:
Zipper Foot, Guide Bar on Swing Gauge & Thumb Screw.

Trademark U.S. PATENT 3140680

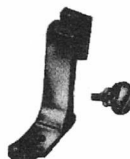

KISSABLE ZIPPER ATTACHMENT, COMPLETE
#SK222

PARTS AVAILABLE SEPARATELY:
#SK223 Kissable Zipper Foot
#SK224 Kissable Zipper Guide Bar Bracket

LAP SEAM FOLDERS

★ FOR SINGER Classes: 112W, 134W, 212G & 212W

LAP SEAM FOLDERS COMPLETE:

- #S112 1/4M (#490361 1/4M) Medium 1/4"
- #S112 1/4H (#490361 1/4H) Heavy 1/4"
- #S112 1/4MH (#490361 1/4MH) Medium-Heavy 1/4"
- #S112 3/16M (#490361 3/16M) Medium 3/16"
- #S112 3/16H (#490361 3/16H) Heavy 3/16"
- #S112 3/16MH (#490361 3/16MH) Medium-Heavy 3/16"

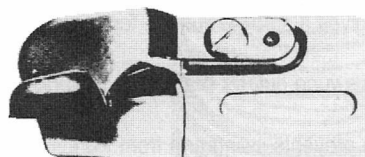

LAP SEAM FOLDERS

FOR SINGER Classes: 231-2, 4, 5, 6, 7, 8, 31, 34 & 35 and 261-1, 2, 3, 20, 31 & 32

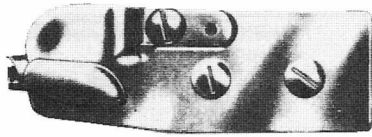

LAP SEAM FOLDER COMPLETE:

# 121586 3/16M Medium $\frac{3}{16}$ "	# 121586 1/4M Medium $\frac{1}{4}$ "
# 121586 3/16H Heavy $\frac{3}{16}$ "	# 121586 1/4H Heavy $\frac{1}{4}$ "
# 121586 3/16MH Medium-Heavy $\frac{3}{16}$ "	# 121586 1/4MH Medium-Heavy $\frac{1}{4}$ "

ALSO AVAILABLE LAP SEAM FOLDERS, COMPLETE FOR SINGER
Class: 231-25:

# 121757 3/16M Medium $\frac{3}{16}$ "	# 121757 1/4M Medium $\frac{1}{4}$ "
# 121757 3/16H Heavy $\frac{3}{16}$ "	# 121757 1/4H Heavy $\frac{1}{4}$ "
# 121757 3/16MH Medium-Heavy $\frac{3}{16}$ "	# 121757 1/4MH Medium-Heavy $\frac{1}{4}$ "

FOR UNION SPECIAL Classes: 35800BQ & 35800DQ

DOUBLE LAP SEAM FOLDERS FOR 8 & 9 GAUGE

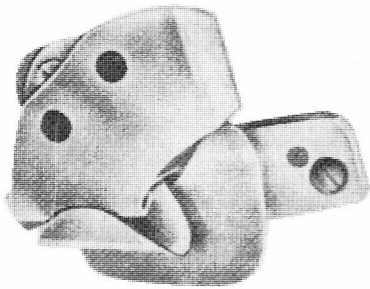

DOUBLE LAP SEAM FOLDERS, COMPLETE (For 8 & 9 Gauge)

23420Z-9-1/8MH Medium Heavy
23420Z-9-1/8H Heavy
23420Z-9-1/8XH Extra Heavy

FOR SINGER Classes: 147-100 & 101, 253-201 & 211 and 262-21 & 22

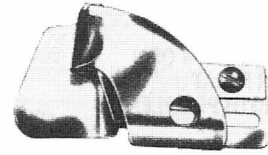

LAP SEAM FOLDER, COMPLETE

160619 3/16M Medium $\frac{3}{16}$ "
160619 3/16H Heavy $\frac{3}{16}$ "
160619 3/16MH Medium-Heavy $\frac{3}{16}$ "
160619 1/4M Medium $\frac{1}{4}$ "
160619 1/4H Heavy $\frac{1}{4}$ "
160619 1/4MH Medium-Heavy $\frac{1}{4}$ "

FOR UNION SPECIAL Class: 51400

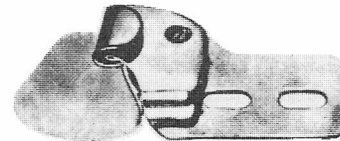

LAP SEAM FOLDER, COMPLETE

23420V 3/16M Medium $\frac{3}{16}$ "
23420V 3/16H Heavy $\frac{3}{16}$ "
23420V 3/16MH Medium-Heavy $\frac{3}{16}$ "
23420V 1/4M Medium $\frac{1}{4}$ "
23420V 1/4H Heavy $\frac{1}{4}$ "
23420V 1/4MH Medium-Heavy $\frac{1}{4}$ "
23420V 1/4XH Extra Heavy $\frac{1}{4}$ "

RUFFLER ATTACHMENT

FOR INDUSTRIAL SEWING MACHINES

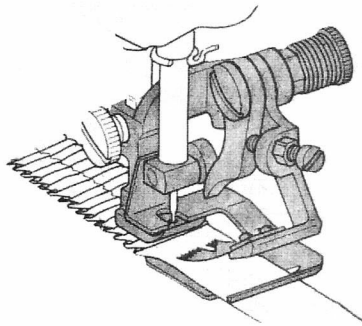

RUFFLER ATTACHMENT, COMPLETE

G9 (# G9E) (# 543023-001)



- ★ Depth of pleat adjustable from 0 to 5 MM
- ★ Recommended for thin fabrics
- ★ Uses one stitch per pleat
- ★ Supplied with one # G9-32 needle clamp
- ★ Feeding amount of pleat controlled by screw on attachment
- ★ Distance between pleats adjusted by feed dog in machine

PARTS AVAILABLE SEPARATELY:

# G9S Blade	# G9-32 Needle Clamp with Roller (Standard Type)
# G9-5 Adjusting Screw	# G9-32A Needle Clamp with Roller (6.35 MM Diameter)
# G9-7 Action Spring	# G9-36 Needle Clamp with Roller (Square Hole)

RUFFLER ATTACHMENT

FOR SINGLE NEEDLE LOCKSTITCH MACHINES
(SINGER, JUKI, BROTHER, MITSUBISHI, ETC.)

- ★ WORKS ON A WIDE RANGE OF FABRICS, EVEN JEANS
- ★ AVAILABLE WITH EITHER 4 OR 8 STITCHES PER PLEAT (GIVING EXTRA STRENGTH PER PLEAT)

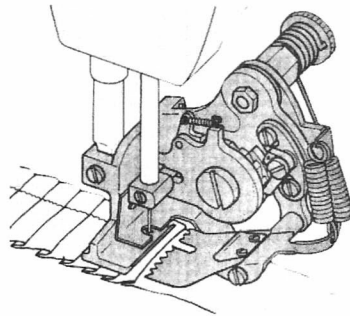

★ DEPTH OF PLEAT ADJUSTABLE FROM 0 TO 10 MM

Feeding amount of pleat controlled by screw on attachment
Distance between pleats adjusted by feed dog in machine.

RUFFLER ATTACHMENT, COMPLETE

#G900 (#G900E)
(★ SUPPLIED WITH ONE #G900-28 NEEDLE CLAMP)

PARTS AVAILABLE SEPARATELY:

- | | |
|---|---|
| #G900S Replaceable Thin Blade (0.2 MM) | #G900-28A Needle Clamp (6.35 MM Diameter) |
| #G900SH Replaceable Heavy Blade (0.5 MM) | #G900-28S Needle Set Screw For #G900-28 Clamp |
| #G900-3E Cam Roller Base With Screw | #G900-29 Spring |
| #G900-8 Action Spring | #G900-CF4S Cam For 4 Stitches |
| #G900-16SP Spring For #G900-16 Feed Plate | #G900-CF8S Cam For 8 Stitches |
| #G900-28 Needle Clamp Standard (7.24 MM Diameter) | #G900-SCR Screw For #G900S Blade |

METRIC CONVERSION TABLE

MILLIMETER TO INCH

1 mm 0.039"	11 mm 0.433"	20 mm 0.787"	29 mm 1.142"
2 mm 0.079"	12 mm 0.472"	21 mm 0.827"	30 mm 1.181"
3 mm 0.118"	13 mm 0.512"	22 mm 0.866"	40 mm 1.575"
4 mm 0.157"	14 mm 0.551"	23 mm 0.906"	50 mm 1.969"
5 mm 0.197"	15 mm 0.591"	24 mm 0.945"	60 mm 2.362"
6 mm 0.236"	16 mm 0.630"	25 mm 0.984"	70 mm 2.756"
7 mm 0.276"	17 mm 0.669"	26 mm 1.024"	80 mm 3.150"
8 mm 0.315"	18 mm 0.709"	27 mm 1.063"	90 mm 3.543"
9 mm 0.354"	19 mm 0.748"	28 mm 1.102"	100 mm 3.937"
10 mm 0.394"			

INCH TO MILLIMETER

1/64" 0.40 mm	19/64" 7.54 mm	37/64" 14.68 mm	11/4" 31.75 mm
1/32" 0.79 mm	5/16" 7.94 mm	19/32" 15.08 mm	13/8" 34.93 mm
3/64" 1.19 mm	21/64" 8.33 mm	39/64" 15.48 mm	11/2" 38.10 mm
1/16" 1.59 mm	11/32" 8.73 mm	5/8" 15.88 mm	13/4" 44.45 mm
5/64" 1.98 mm	23/64" 9.13 mm	21/32" 16.67 mm	2" 50.80 mm
3/32" 2.38 mm	3/8" 9.53 mm	11/16" 17.46 mm	21/4" 57.15 mm
7/64" 2.78 mm	25/64" 9.92 mm	23/32" 18.26 mm	21/2" 63.50 mm
1/8" 3.18 mm	13/32" 10.32 mm	3/4" 19.05 mm	23/4" 69.85 mm
9/64" 3.57 mm	27/64" 10.72 mm	25/32" 19.84 mm	3" 76.20 mm
5/32" 3.97 mm	7/16" 11.11 mm	13/16" 20.64 mm	31/4" 82.55 mm
11/64" 4.37 mm	29/64" 11.51 mm	27/32" 21.43 mm	31/2" 88.90 mm
3/16" 4.76 mm	15/32" 11.91 mm	7/8" 22.23 mm	33/4" 95.25 mm
13/64" 5.16 mm	31/64" 12.30 mm	29/32" 23.02 mm	4" 101.60 mm
7/32" 5.56 mm	1/2" 12.70 mm	15/16" 23.81 mm	41/4" 107.95 mm
15/64" 5.95 mm	33/64" 13.10 mm	31/32" 24.61 mm	41/2" 114.30 mm
1/4" 6.35 mm	17/32" 13.49 mm	63/64" 25.00 mm	43/4" 120.65 mm
17/64" 6.75 mm	35/64" 13.89 mm	1" 25.40 mm	5" 127.00 mm
9/32" 7.14 mm	9/16" 14.29 mm	11/8" 28.58 mm	6" 152.40 mm